

VIDEOKIT

VK4K/6256 SERIES

"6 Wire" bus one way, two way videokit

VK4K

VK4KC

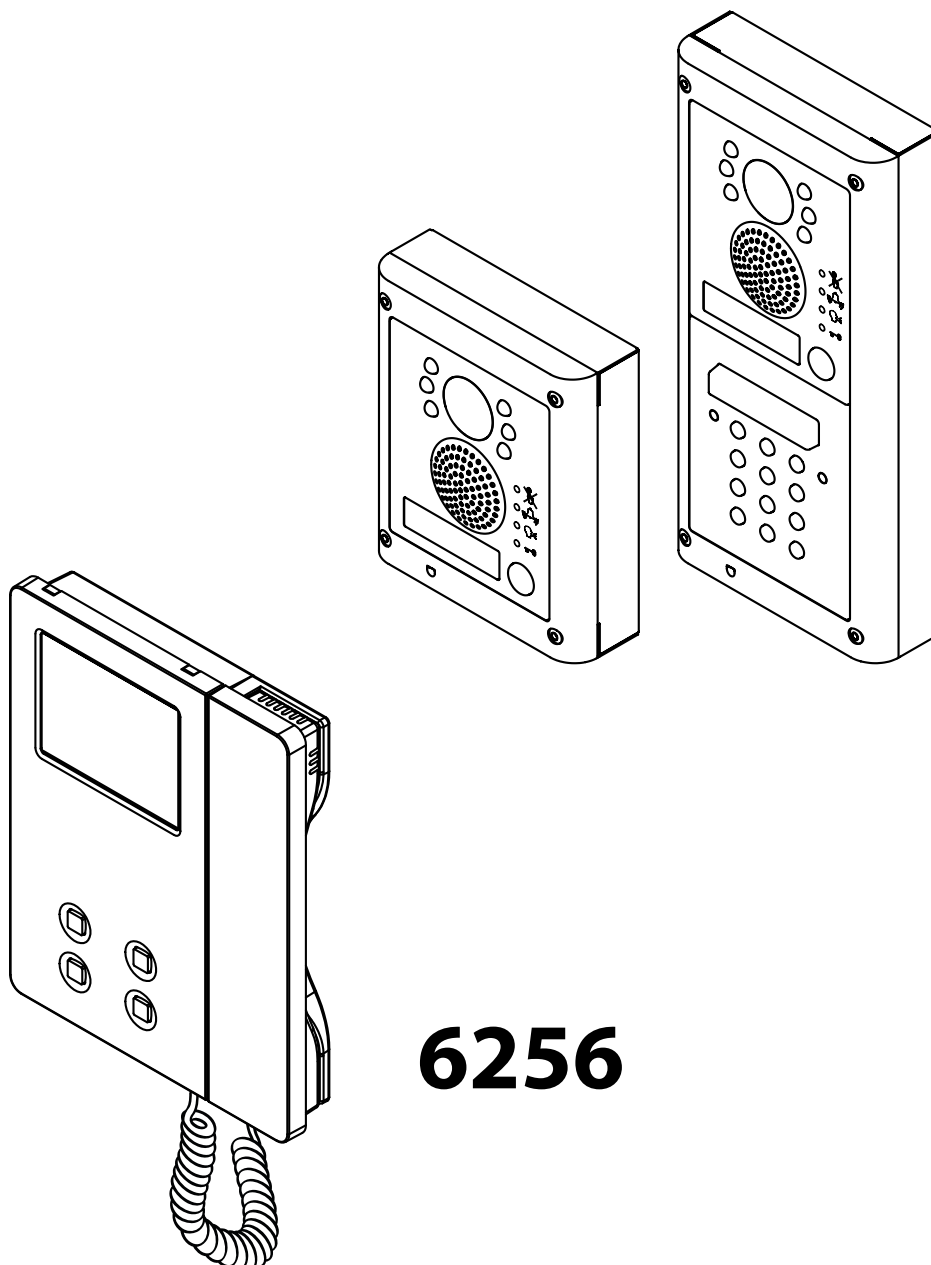

Installation handbook

Index

Introduction	2
System components and available versions	3
General directions for installation	5
Troubleshooting guide	6
Art. 4833 Speaker unit	7
Art. 4800 - 4800M Digital codelock module	10
4000 Series surface and flush mounting door station installation	13
Art. 6256 3.5" colour videophone	15
6200 Series Videophone wall mounting instructions	18
Installation diagrams	19

Introduction

The VK4K Series is a new range of videokits that use the 4000 Series external door station and the Art. 6256 Series videophone. The camera / audio unit is the size of a single 4000 Series module and is available in either flush (VK4K) or surface (VK4K-S) mounting versions.

As a result of using microprocessor technology in the door panel and videophone, a number of additional features have been added to enhance the operation of the videokits and give greater feedback to the visitor and user.

- Disability friendly, visual and acoustic signals from the door panel to inform the visitor of call status (call made, ringing, speak, door open).
- Programmable door open and conversation time.
- Expandable to 4 entrance panels (requires an additional relay Art. 506N for each entrance panel).
- Connections for a push to exit button.
- Two methods of operating the electric lock:- 1) Dry contact relay, 2) capacitor discharge 12Vdc output.
- Facility for the connection of a codelock Art. 4800M, display module Art. 4820, stand-alone proximity reader Art. 4850 or stand-alone biometric reader Art. 4821 etc.
- Programmable number of call tone rings from 2 to a maximum of 8.
- Input for local door bell push button.
- Programmable timed privacy function from 15 minutes to a maximum of 8 hours.
- Door open status LED (additional wire required from the door to the videophone)
- Up to 4 videophones can be connected in parallel, all with intercommunication facility.
- Videophones can have a maximum of two additional audio telephone handsets connected in parallel.
- Camera recall on all systems, with selective recall on systems with multiple entrances.
- Door panel camera can be adjusted horizontally and vertically (10 degrees).

System components and available versions

VK4K/6256 Colour videokit.

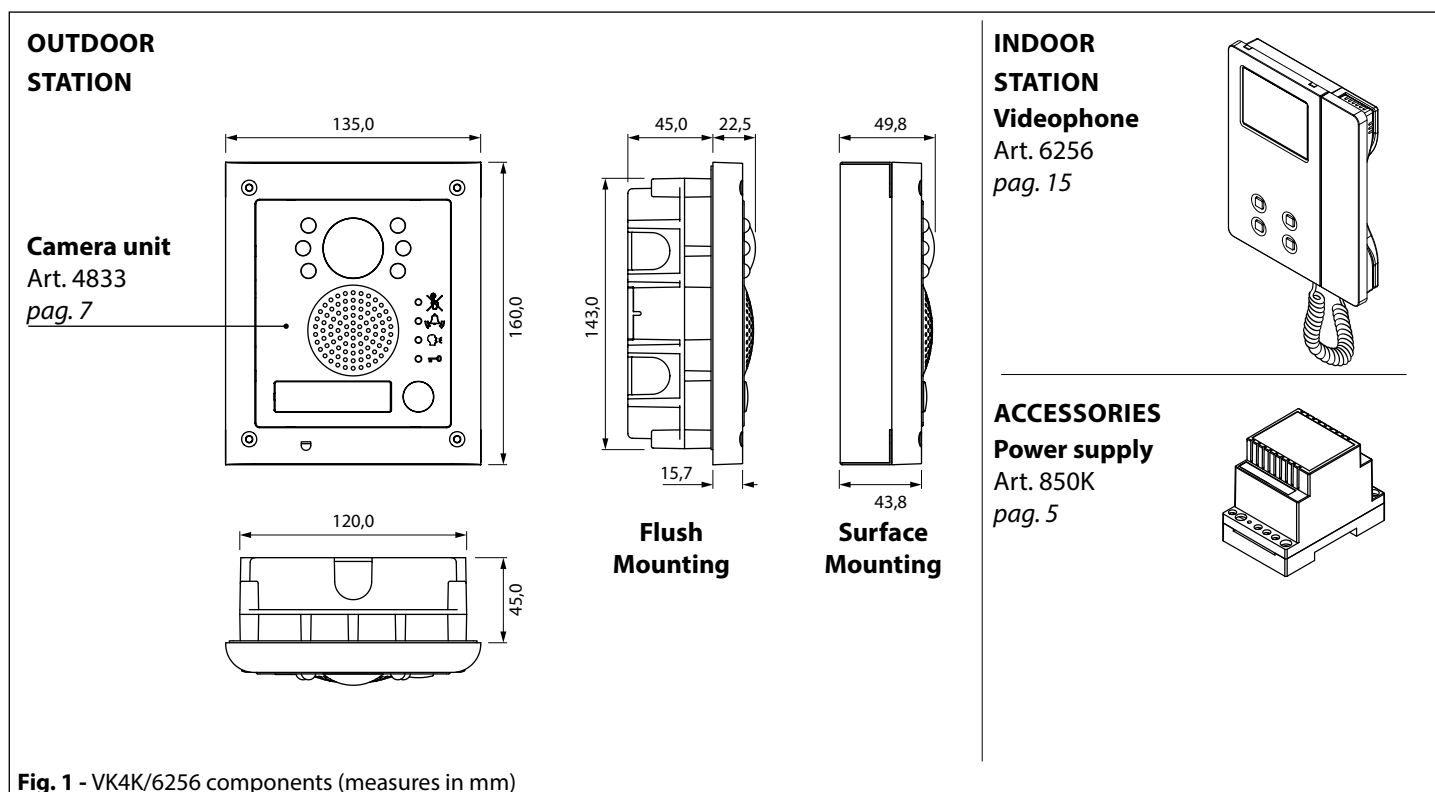

Fig. 1 - VK4K/6256 components (measures in mm)

	VK4K-1/6256 - flush mounting		1 Colour videophone Art. 6256		1 Power supply Art. 850K
ONE WAY VERSIONS	<p>1 Outdoor station composed of: 1 Art. 4833-1/C: 1 button camera unit 1 Art. 4851: Flush mounting box</p>				
	<p>1 Outdoor station composed of: 1 Art. 4833-1/C: 1 button camera unit 1 Art. 4881: Surface mounting box</p>		1 Colour videophone Art. 6256		1 Power supply Art. 850K
TWO WAY VERSIONS	<p>1 Outdoor station composed of: 1 Art. 4833-2/C: 2 buttons camera unit 1 Art. 4851: Flush mounting box</p>		2 Colour videophones Art. 6256		2 Power supplies Art. 850K
	<p>1 Outdoor station composed of: 1 Art. 4833-2/C: 2 buttons camera unit 1 Art. 4881: Surface mounting box</p>		2 Colour videophones Art. 6256		2 Power supplies Art. 850K

VK4KC/6256 Colour videokit plus a codelock module.

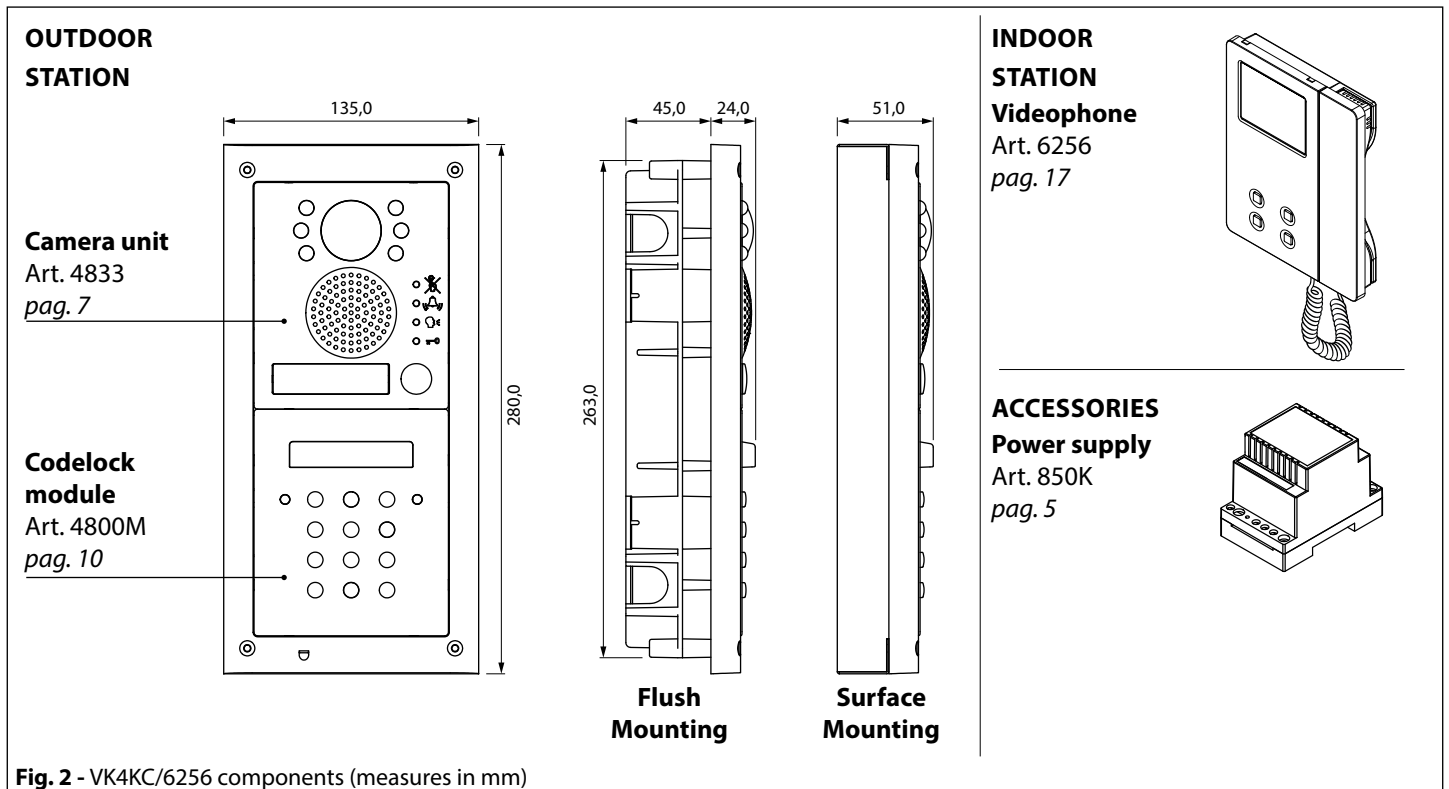

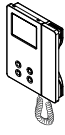

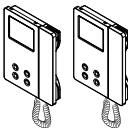
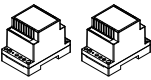
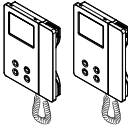
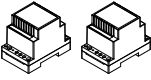

Fig. 2 - VK4KC/6256 components (measures in mm)

ONE WAY VERSIONS	VK4KC-1/6256 - flush mounting	1 Outdoor station composed of: 1 Art. 4833-1/C: 1 button camera unit 1 Art. 4800M: Codelock module 1 Art. 4852: Flush mounting box	 1 Colour videophone Art. 6256	 1 Power supply Art. 850K
	VK4KC-1S/6256 - surface mounting	1 Outdoor station composed of: 1 Art. 4833-1/C: 1 button camera unit 1 Art. 4800M: Codelock module 1 Art. 4882: Surface mounting box	 1 Colour videophone Art. 6256	 1 Power supply Art. 850K
TWO WAY VERSIONS	VK4KC-2/6256 - flush mounting	1 Outdoor station composed of: 1 Art. 4833-2/C: 2 buttons camera unit 1 Art. 4800M: Codelock module 1 Art. 4852: Flush mounting box	 2 Colour videophones Art. 6256	 2 Power supplies Art. 850K
	VK4KC-2S/6256 - surface mounting	1 Outdoor station composed of: 1 Art. 4833-2/C: 2 buttons camera unit 1 Art. 4800M: Codelock module 1 Art. 4882: Surface mounting box	 2 Colour videophones Art. 6256	 2 Power supplies Art. 850K

General directions for installation

CONNECTION TO MAINS

The system must be installed according to national rules in force, in particular we recommend to:

- Connect the system to the mains through an **all-pole circuit breaker** which shall have contact separation of at least 3mm in each pole and shall disconnect all poles simultaneously;
- The **all-pole circuit breaker** shall be placed for easy access and the switch shall remain readily operable.

POWER SUPPLY INSTALLATION

- Remove the terminal side covers by unscrewing the retaining screws;
- Fix the power supply to a DIN bar or directly to the wall using two expansion type screws;
- Switch off the mains using the circuit breaker mentioned above and then make the connections as shown on the installation diagrams;
- Check the connections and secure the wires into the terminals;
- Replace the terminal covers and fix them using the relevant screws;
- When all connections are made, restore the mains.

CABLE SIZE

Video connections and Audio connections must be wired in twisted pair: pair the video lines (terminals/signals "V1" and "V2"), pair the audio lines (terminals /signals "1" and "2").

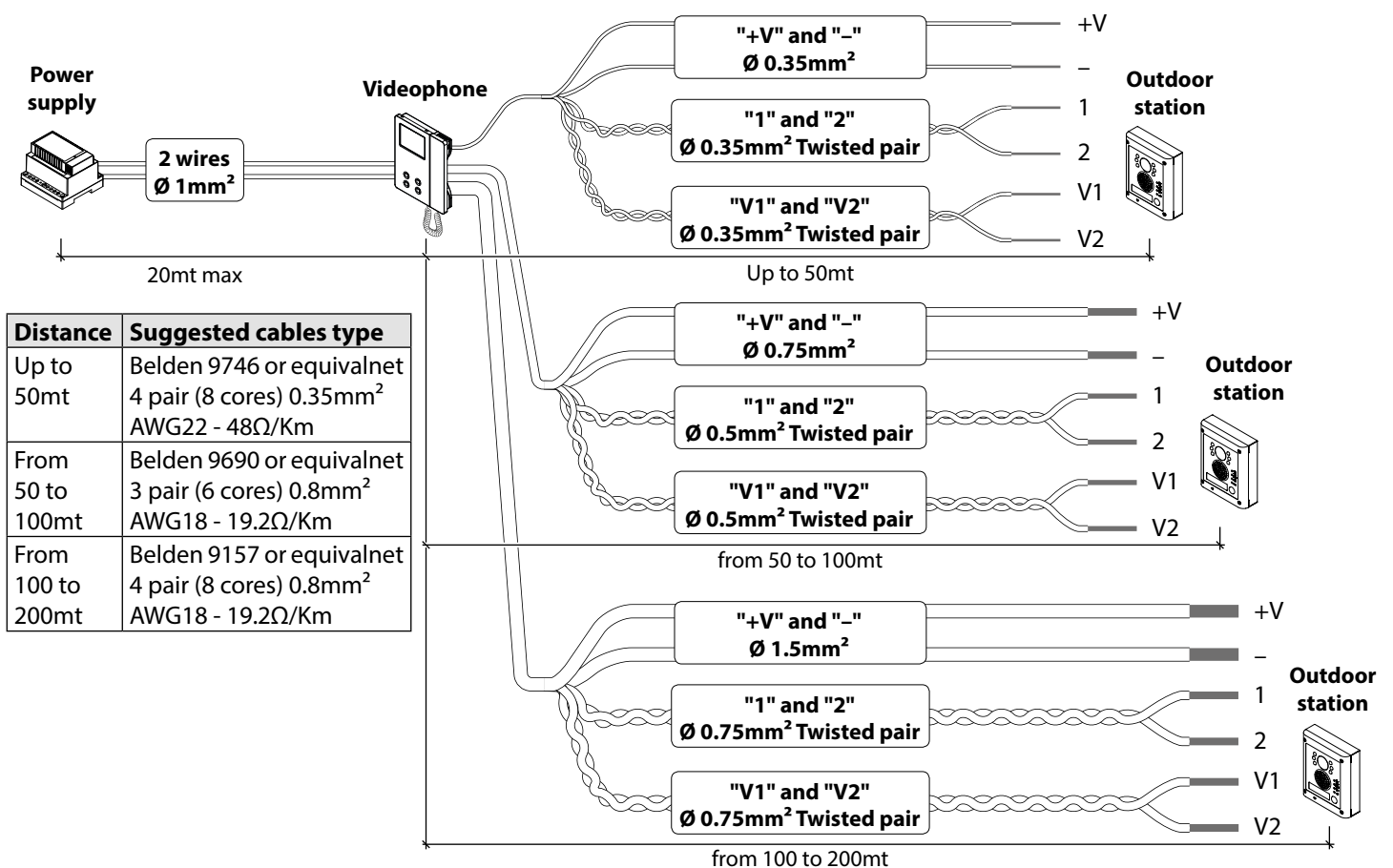
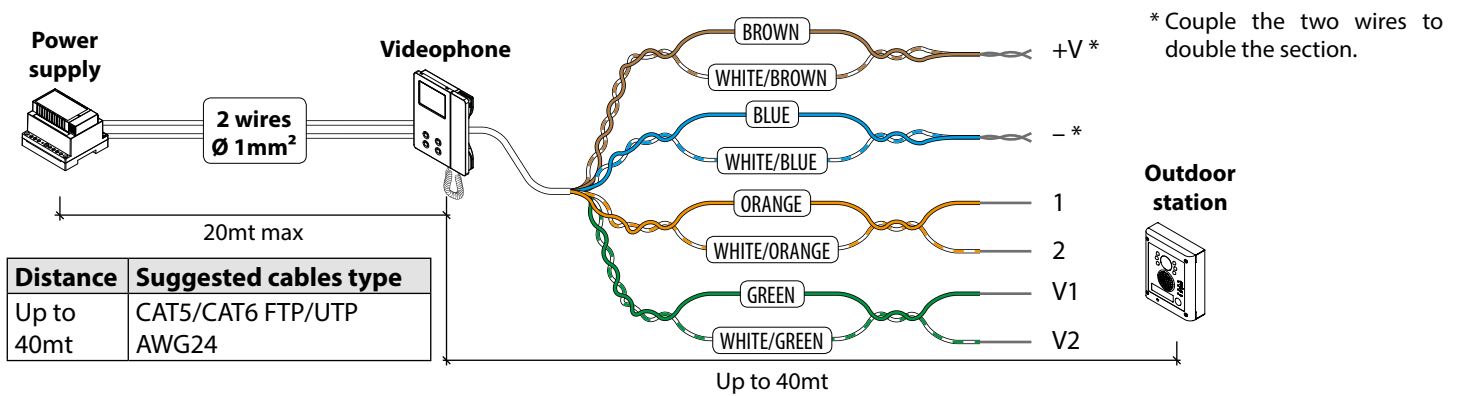

Troubleshooting guide

In case of system failure, try the following preliminary checks:

- Check that the cables are connected as shown in the installation diagram and that the cables are firmly fixed into the relevant terminals;
- Check that the mains voltage is available on terminals 230Vac (or 127Vac) and 0 of the power transformer Art. 850K;
- Check the 24Vac voltage output of the power transformer Art. 850K. If this voltage is not available it could be the 1,6A fuse, in this case remove the mains voltage, remove possible short-circuits or overload sources then replace the fuse with an equal or equivalent one.
- Check that the voltage between the terminals "+" and "-" of the speaker unit is between 16 and 20Vdc.

If the problem persists try the tests in the following table or contact technical support.



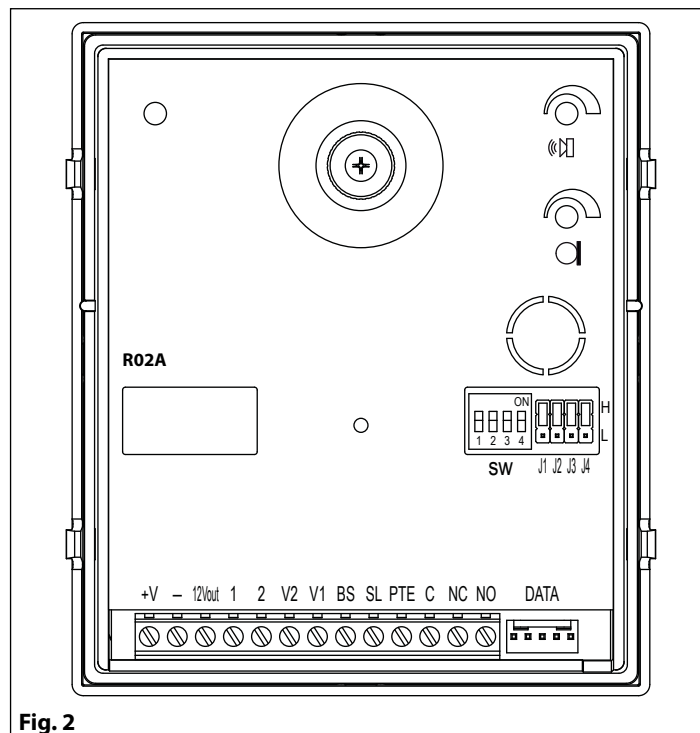
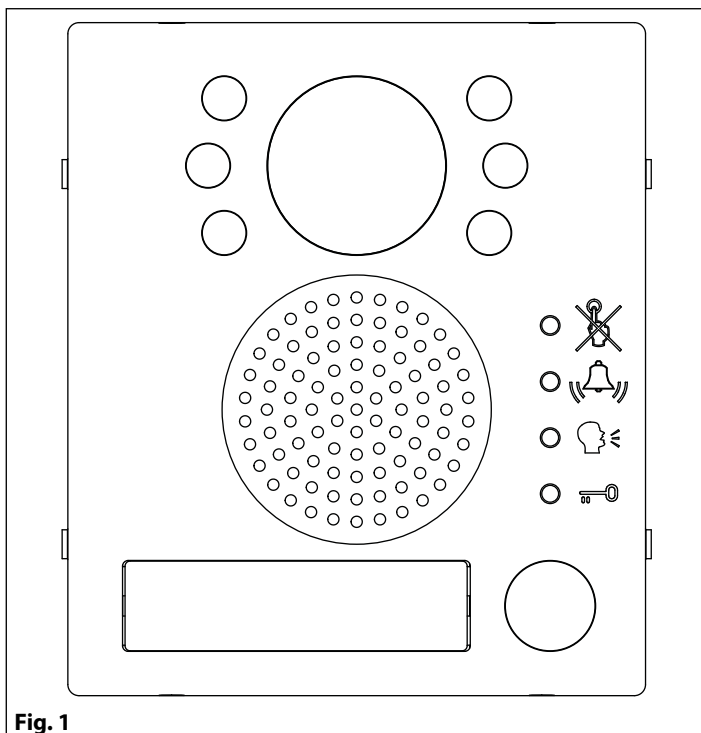

SYMPTOM	CAUSE	SOLUTION
The door station is not able to call the extension (the bell LED is switched on for 2 seconds):	<ul style="list-style-type: none"> • Wrong connection between door station and the videophone • Cable size too small. • Programmed videophone address incorrect. • You have changed the videophone address without power down the system. 	<ul style="list-style-type: none"> • Check the 6 common wire connections especially wire "1" (speech line/data). • Increase cable size or double up using two wires for each connection. • Check videophone address on dip-switches. • Power down the system then power up again to detect the new videophone address.
External call works but when answered the communication fails:	<ul style="list-style-type: none"> • Cable size too small. 	<ul style="list-style-type: none"> • Increase cable size or double up using two wires for each signal.
During the conversation it is not possible to open the door:	<ul style="list-style-type: none"> • Cable size too small. 	<ul style="list-style-type: none"> • Increase cable size or double up using two wires for each signal.
During the conversation it is not possible to open the door but the key LED on the door station switches on for the programmed time:	<ul style="list-style-type: none"> • Incorrect position of J2 jumper. • Electric lock wires unconnected or in short. • Wrong electric lock type. 	<ul style="list-style-type: none"> • Check J2 position on the door station. • Check connection. • Check that the electric lock type (ac or dc) is suitable for the J2 position chosen.
Speech only from outside to inside:	<ul style="list-style-type: none"> • Wire "2" broken or in short. 	<ul style="list-style-type: none"> • Check connection of wire "2".
Low volume of speech:	<ul style="list-style-type: none"> • Volume trimmers of door station require adjustment. 	<ul style="list-style-type: none"> • Adjust the trimmers until the required volume is reached.
Noise over the speech line during the conversation:	<ul style="list-style-type: none"> • The 6 common wires are cabled together with 230 or 380Vac power lines. • The 6 common wires are cabled together with 24Vac videophone power supply wires. 	<ul style="list-style-type: none"> • Separate the 6 common wires from the high voltages cables. • Separate the 6 common wires from the two 24Vac wires or cable them together only for a short distance.
Camera recall service does not work:	<ul style="list-style-type: none"> • Camera recall button pressed for a number of times different from the ID of the door station to be switched on. 	<ul style="list-style-type: none"> • Check the ID (1..4) of the door station to be recalled and press the camera recall button as many time as the ID value.
Intercommunicating call does not work:	<ul style="list-style-type: none"> • "Key" button pressed for a number of times different from the videophone address value. 	<ul style="list-style-type: none"> • Check the address of the videophone you are calling and try again.
The video shown on the monitor is of a bad quality and the image is distorted or double	<ul style="list-style-type: none"> • V1,V2 signals unconnected, reversed or shorted. • The switches of the two way dip-switch are not both in ON position. • V1,V2 of the last Art. 316N (if present) not closed with 75 Ohm resistor. 	<ul style="list-style-type: none"> • Check that the wires are not broken or shorted. • Set both switches to the ON position. • Use 2x 75 Ohm resistors to connect V1 & V2 to 0V.
Local call does not work:	<ul style="list-style-type: none"> • Wrong connection or call button broken. 	<ul style="list-style-type: none"> • Check connection or replace the button.



Art. 4833 Speaker unit



DESCRIPTION



Speaker unit module Art. 4833 comprising of high quality auto iris lens CCD Day/Night colour camera with infrared illumination LEDs.

LEDS	
	When illuminated, indicates that it is not possible to make a call because a call or a conversation is in progress (from the outdoor station from which you are calling or from another outdoor station on systems with multiple entrances). The LED will be off when the system is in stand-by.
	If illuminated, indicates that the call from the outdoor station is in progress. The LED will switch OFF when the call is answered or after the programmed number of rings.
	If illuminated, indicates that it is possible to speak because the call has been answered. The LED will switch OFF at the end of a conversation (or at the end of the conversation time).
	If illuminated, indicates that the door lock has been operated. It will switch OFF at the end of the programmed "door opening" time.





CONTROLS (SPEAKER & MICROPHONE VOLUME)	
	Trimmer to adjust the speaker volume. Rotate clockwise to increase or anticlockwise to decrease.
	Trimmer to adjust the microphone volume. Rotate clockwise to increase or anticlockwise to decrease.

SETTINGS (DIP-SWITCH & JUMPERS)
4 WAY DIP-SWITCH

First two switches are used to set the speaker unit address: the speaker unit address is required for camera recall operation on 2 or more entrance systems.

 SW	Switches 1,2 OFF OFF ON OFF OFF ON ON ON	Unit Address 1 2 3 4
 SW	Switches 3 OFF ON	Conversation Time 60 seconds 120 seconds
 SW	Switch 4 OFF ON	Door opening time (J2 = "L" position) 2 seconds 6 seconds

JUMPERS J1, J2, J3, J4

 J1 J2 J3 J4	J1 Position H L	Call reassurance tone volume High Low
 J1 J2 J3 J4	J2 Position H L	Door open relay operating mode Capacitor discharge Dry contacts
 J1 J2 J3 J4	J3 Position H L	Call buttons operating mode (only for Art. 4833) Each button calls a different videophone Both buttons call the same videophone (Address 1)
 J1 J2 J3 J4	J4 Position H L	Built-in relays – back EMF protection (MOV) NC contact NO contact

When the door open relay operating mode is set to "capacitor discharge"*, one terminal of the electric lock must be connected to ground while the second must be connected to "NO" terminal. The "NO" terminal will supply a temporary voltage when the speaker unit receives the door open command.

* When "capacitor discharge" operating mode is set, one terminal of the electric lock must be connected to the ground while the second one must be connected to "NO" terminal. The "NO" terminal will supply a temporary voltage when the speaker unit receives the door open command (we suggest to use a 12Vac/dc 1A max electric lock). Setting "dry contacts" operating mode, when the speaker unit receives the door open command, the "NO" terminal will be internally linked to the "C" terminal for the programmed time (switch 4 of the 4 way dip-switch bank).

BUILT-IN RELAYS – BACK EMF PROTECTION

The Art. 4833 includes selectable back EMF protection on the relays. The jumpers marked J4 (One jumper for each relay) are used to select the protection type. When using a fail secure lock with connections C & NO the jumper should be in the NO position. When using a fail open lock with connections C & NC the jumper should be in the NC position and when using the codelock to trigger a gate controller or another third party controller the jumper should be removed completely (This disables the protection on the relay).

LOCK RELEASE BACK EMF PROTECTION

A varistor must be fitted across the terminals on AC lock release (**Fig.1A**) and a diode must be fitted across the terminals on a DC lock release (**Fig.1B**) to suppress back EMF voltages. Connect the components to the lock releases as shown in figures.

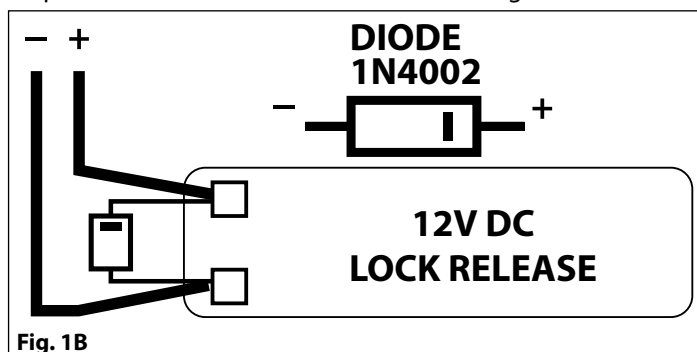
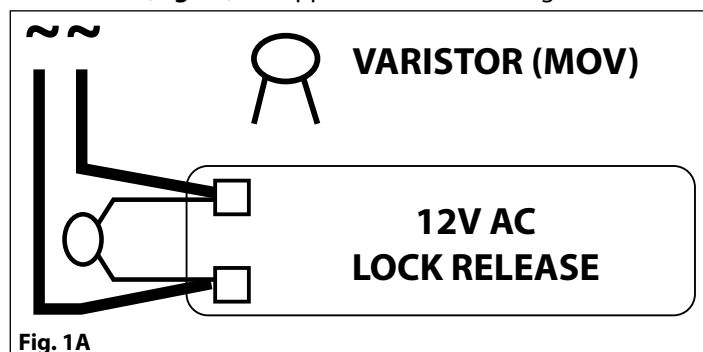

SIGNALS		
+V	Power input 16÷20Vdc	
-	Power input ground	
12Vout	12Vdc, 0,3A max. output to supply accessories	
1	Speech line input toward the loudspeaker and data signal (about 12V in stand-by, about 5V with a conversation in progress)	
2	Speech line output from the microphone (about 12V in stand-by, about 3V with a conversation in progress)	
V1	Balanced video signal sync.-	
V2	Balanced video signal sync.+	
BS	Input/Output busy signal (about 12V in stand-by, about 0V with a call in progress)	
SL	Active low output to enable the enslavement relay for video signal exchange (active with a call in progress)	
PTE	Active low input to control directly the door open relay	
C	Door open relay common contact	Max 24Vdc, 3A when used as dry contacts relay
NC	Door open relay normally closed contact	
NO	Door open relay normally open contact	

TECHNICAL SPECIFICATION

Power Supply: Supplied by the BUS line, 20Vdc

Power consumption: Stand-by: 70mA
Operating: 250mA

Working Temperature: -10 +50° C

Art. 4800M Digital codelock module

CODELOCK UNIT MODULES ART. 4800M

The module features 12 stainless steel buttons (Keys **0 - 9**, **ENTER** and **CLEAR**), 2 LED's for progress information during use and programming and a mirror finish stainless steel front plate (Standard version). With three integral relays each with common, normally open and normally closed connections and two inputs to enable the external triggering of relays one and two (For example, push to exit button). Key presses are signalled both acoustically and visually while each button press has a tactile feel. Entering the correct code followed by ENTER will activate the relevant relay. Programming is carried out through the same keypad following a simple programming menu. The module can be combined with other 4000 Series modules in an audio or video intercom system.

MAIN FEATURES

- 3 C, NC, NO relay outputs (24Vac/dc – 5A max);
- 3 Programmable secret codes (one for each relay);
- Each relay can be set to be activated for a specific time (01 to 99 seconds) or to work as latch;
- Two active low inputs to command directly the relay 1 and 2;
- Programming menu guarded by a 4-8 digit programmable engineer's code;
- Visual and Acoustic signal during operating and programming;
- Keypad illumination LEDs;

GENERAL DIRECTIONS FOR INSTALLATION

In order to achieve the best results from the schematics described it is necessary to install only original VIDEX equipment, strictly keeping to the items indicated on each schematic and follow these General Directions for Installation:

- The system must be installed according to national rules in force, in any case the running of cables of any intercom unit must be carried out separately from the mains;
- All multipair cables should be compliant to CW1308 specification (0.5mm twisted pair telephone cable).
- Cables for speech line and service should have a max resistance of 10 Ohm
- Lock release wires should be doubled up (Lock release wires and power supply wires should have a max resistance of 3 Ohm);
- The cable sizes above can be used for distances up to 50m. On distances above 50m the cable sizes should be increased to keep the overall resistance of the cable below the RESISTANCES indicated above;
- Double check the connections before power up;
- Power up the system then check all functions.

LOCK RELEASE BACK EMF PROTECTION

A varistor must be fitted across the terminals on AC lock release (**Fig.1A**) and a diode must be fitted across the terminals on a DC lock release (**Fig.1B**) to suppress back EMF voltages. Connect the components to the lock releases as shown in figures.

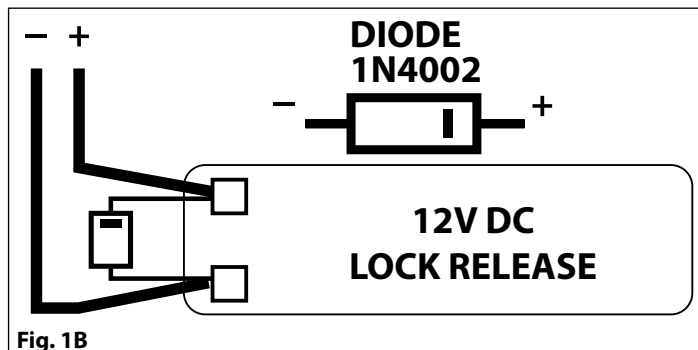
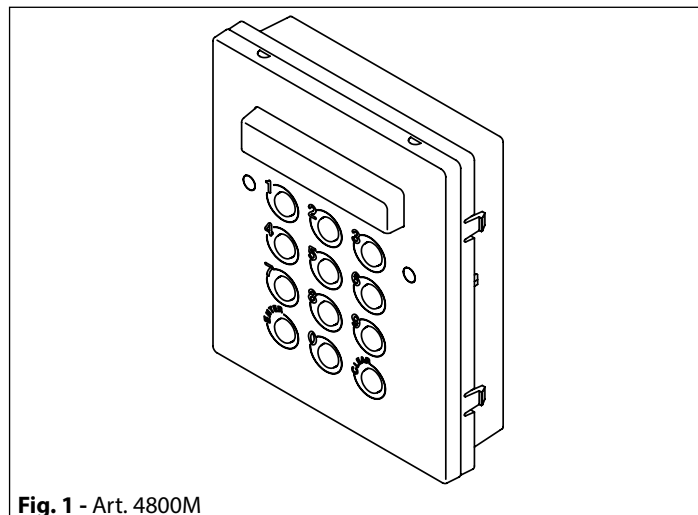
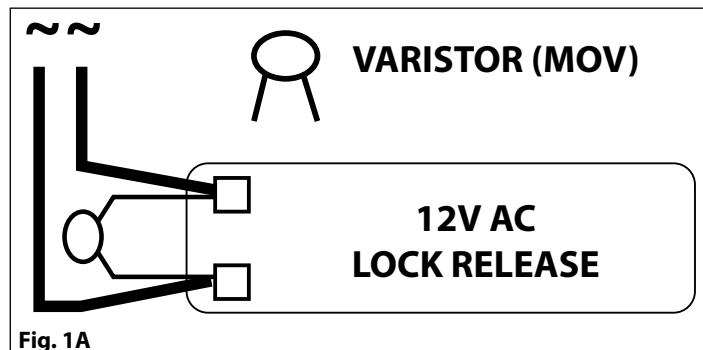

BUZZER BACK EMF

When using intercoms with buzzer call (Art.924/926, SMART1/2, 3101/2, 3001/2 and 3021/2) add one 0.1uF (100nF) capacitor between terminals 3 and 6 on the telephone.

BUILT-IN RELAYS – BACK EMF PROTECTION

The Art. 4800M includes selectable back EMF protection on the relays. The jumpers marked MOV (One jumper for each relay) are used to select the protection type. When using a fail secure lock with connections C & NO the jumper should be in the NO position. When using a fail open lock with connections C & NC the jumper should be in the NC position and when using the codelock to trigger a gate controller or another third party controller the jumper should be removed completely (This disables the protection on the relay).

PROGRAMMING (SEE ALSO THE RELEVANT FLOW CHART)

- Enter the "ENGINEER'S CODE": first time type six times "1" (111111 factory preset) and press "ENTER" (The red LED will illuminate);
- Confirm "ENGINEER'S CODE" (typing again the same) or type the new code (4 to 8 digits) then press "ENTER" (Melody). Pressing twice the "ENTER" button without changing the "ENGINEER'S CODE", will exit from the programming;
- Enter the code (4 to 8 digits) to enable "RELAY 1" or re-enter the existing code then press "ENTER" (Melody);
- Enter the "RELAY 1" operation time (2 digits 01 to 99 I.E. 05=5 seconds, 00= remain open time) or re-enter the existing time then press "ENTER" (Melody);
- Enter the code (4 to 8 digits) to enable "RELAY 2" or re-enter the existing code then press "ENTER" (Melody);
- Enter the "RELAY 2" operation time (2 digits 01 to 99 I.E. 05=5 seconds, 00= remain open time) or re-enter the existing time then press "ENTER" (Melody);
- Enter the code (4 to 8 digits) to enable "RELAY 3" or re-enter the existing code then press "ENTER" (Melody);
- Enter the "RELAY 3" operation time (2 digits 01 to 99 I.E. 05=5 seconds, 00= remain open time) or re-enter the existing time then press "ENTER" (Melody);
- The system is ready to use (the red LED will be off).

PROGRAMMING NOTES

- After pressing enter following a command, press "ENTER" a further twice to exit the programming menu.

RETURN SYSTEM TO PRESET ENGINEER'S FACTORY CODE

- Turn off power to code lock;
- Keep "ENTER" button pressed while turning the power back on;
- Release "ENTER" button;
- The engineer's code is now set to "111111" (six times one).

OPERATION

- Type in the programmed code and press "ENTER";
- If the code is correct, the green LED will illuminate for approx. 2 seconds and the relay relevant to the code will operate for the programmed time;
- If a wrong code is entered, a continuous melody will sound for 4 or more seconds, according to the number of mistakes;
- To switch off any relay while operating, type in the relevant code then press the "CLEAR" button;

OPERATION NOTES

- To operate relays together, set the same code for each relay;
- If a wrong code is entered, the system will lock out for 5 seconds which will increase each time a wrong code is entered. The system will operate only when the correct code is entered.

TERMINALS:		
SW2	Relay 2 command signal (active low)	Max 24Vac/dc 3A
SW1	Relay 1 command signal (active low)	
NC3	Relay 3 normally closed contact	
NO3	Relay 3 normally open contact	
C3	Relay 3 common contact	
NC2	Relay 2 normally closed contact	
NO2	Relay 2 normally open contact	
C2	Relay 2 common contact	
NC1	Relay 1 normally closed contact	
NO1	Relay 1 normally open contact	
C1	Relay 1 common contact	
-	12/24Vac/dc power input	
+		

TECHNICAL SPECIFICATION

Power Supply: 12/24 Vac/dc – 2VA
Power Consumption: Stand-by: 20mA
 Operating: 70mA
Working Temperature: -10 +50° C

PROGRAMMING FLOW-CHART

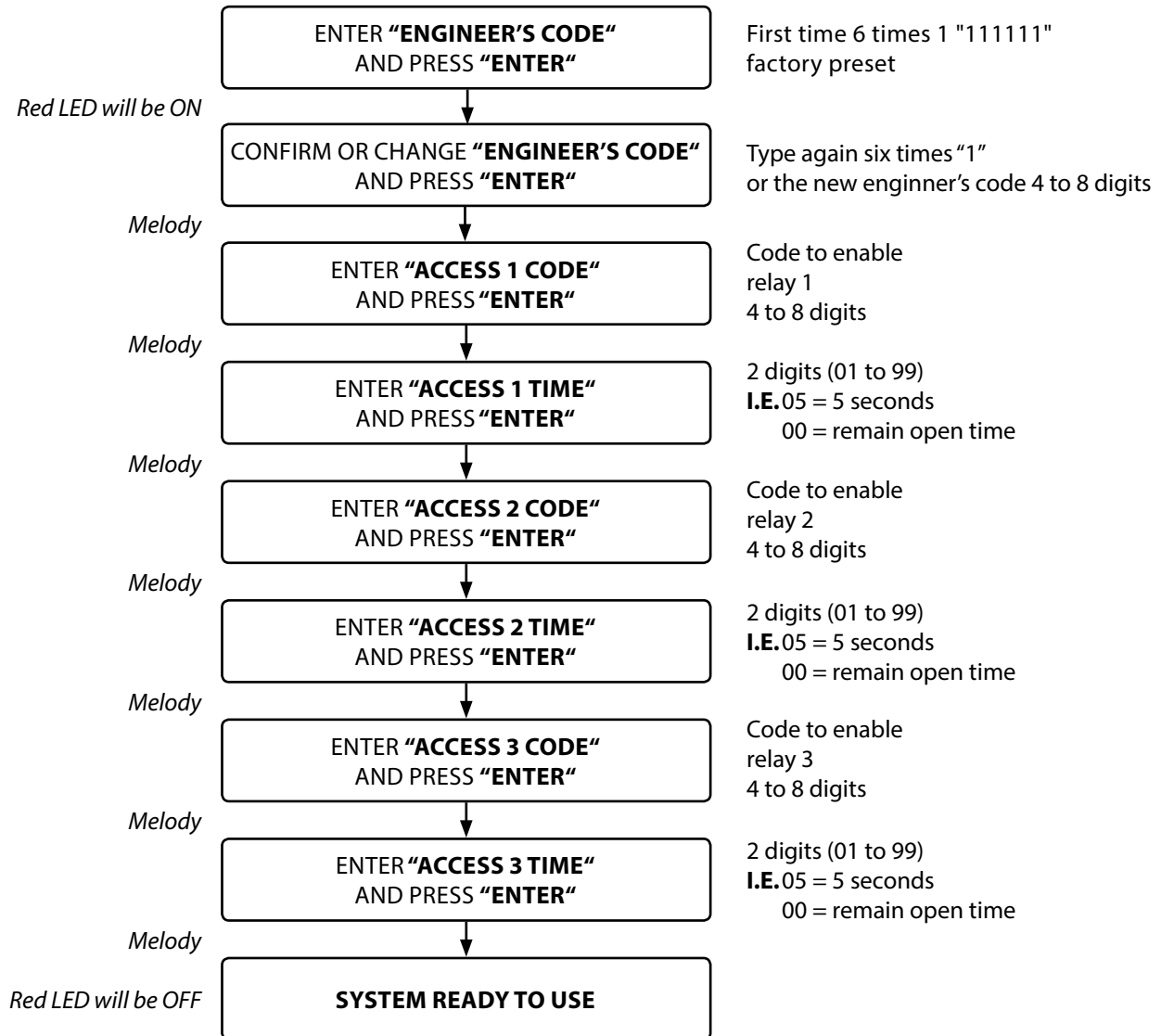

4000 Series Surface and flush mounting door station installation

EXAMPLE: INSTALLING A FOUR MODULE OUTDOOR STATION

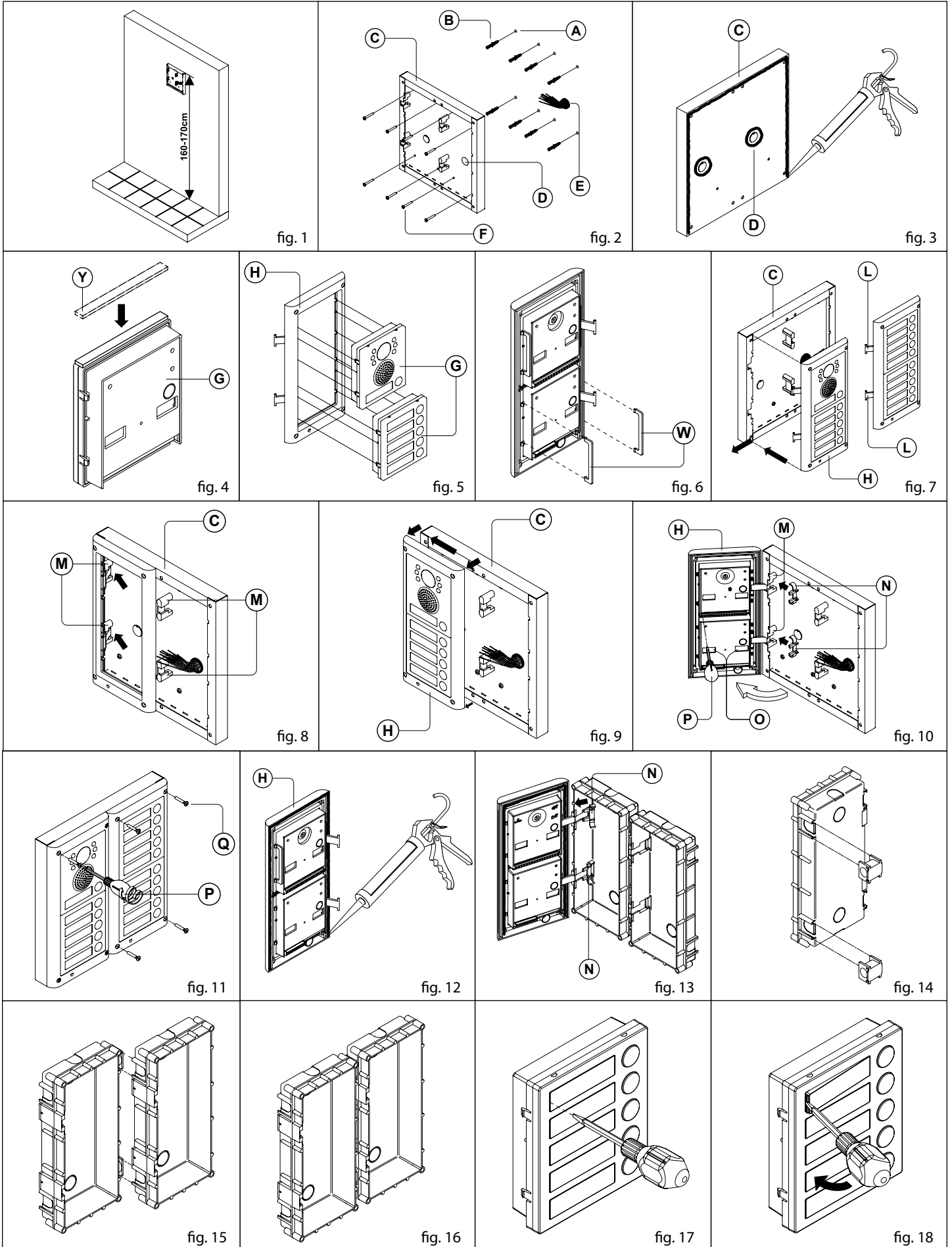

INSTALLING A SURFACE MOUNT DOOR STATION

1. Place the surface box against the wall (165-170cm between the top of the box and the floor level as shown in **Fig. 1**) and mark the fixing holes for the wall plugs and the hole for the cables **E (fig. 2)**. Observe the orientation of the box with the hinge on the left;

 **In order to prevent water ingress we highly recommend using a silicon sealant between the wall and the back box C (Fig.3) and around all holes D (Fig.3);**

2. As shown on **Fig. 2**, drill the fixing holes **A**, insert the wall plugs **B** and feed the cables **E** through the surface box opening **D**, fix surface box **C** to the wall using the screws **F**;
3. Apply the **Y** silicon sealant on top of each module as shown in **Fig. 4**;
4. Before installation of the module support frame, hook the modules **G** to the support frame **H** as shown in **Fig. 5** then, as shown in **Fig. 6**, fit the two anti-tampering locks **W** for each module (do the same for the second module support frame);
5. When you have more than one support frame, hook the support frame to the surface box starting from the left. For convenience we will described how to attach the left frame but the same must be carried out for the right frame. As shown in **Fig. 7**, hook the module support frame **H** (complete with modules) to the surface box **C** moving the frame as suggested from pointers. Ensure that the pivots **L (Fig. 7)** go inside the relevant housing **M** as shown in **Fig. 8**;
6. As shown on **Fig. 9**, pull back the module support frame **H** while moving it slightly to the left as suggested by the pointers;
7. As shown in **Fig. 10**, open the module support frame **H** as suggested by the pointer, hook the hinge locks **N** to the hinges **M**, make the required connections using the screwdriver provided **P** (flat blade end) and make the required adjustment by adjusting the settings (through openings **O**) and adjust trimmers;
8. Repeat the same operations described above for the second module support frame (or for the third if available);
9. When the system has been tested and is working correctly, move back the module support frames carefully, fix them to the surface box using the screwdriver provided **P** (torx end) and the pin machine torx screws **Q (Fig. 11)**. **Note: do not over tighten the screws more than is necessary.**

INSTALLING A FLUSH MOUNTING DOOR STATION

When flush mounting and the number of modules is greater than 3, the required back boxes need to be linked together (before embedding them in the wall) as shown on **Fig. 14, 15 and 16**:

- Arrange the back boxes and remove knockouts to allow cables to be fed from one back box to the other;
 - Hook the spacers to first back box then hook the second back box to obtain the result shown on **Fig. 16**;
1. Protect the module support frame fixing holes from dust then embed the back box into the wall (165-170cm between the top of the box and the floor level as shown on the **Fig. 1**) feeding the cables **E (Fig. 2)** through a previously opened hole in the box. Observe the direction of the box ensuring the hinge is on the left and take care that the box profile is in line with the finished wall profile;

 **In order to prevent water ingress we highly recommend using a silicon sealant between the wall and the back box H (Fig.12);**

2. Continue from step **4** of surface mounting instructions , but at step **7** hook the hinge locks **N** as shown on **Fig. 13**.

 **Note: if additional holes are made in the surface box, oxidation problems may appear unless the unprotected metal is coated with a protective paint.**

NOTES

- The screwdriver's blade has two sides, one flat and one torx, to select one of them unplug the blade from the screwdriver body and plug it into the required side.
- The example shows the use of only one back box bottom hole for wires, this is done to keep file drawings clear. Naturally the installer can use the left hole or the right or both if required.

HOW TO REMOVE THE CARD NAME HOLDER

- To avoid damage to the module front plate, tape the side that will be in contact with the screwdriver blade;
- Insert the screwdriver (flat side) into the card-holder hole as shown in **Fig. 17**;
- Move the screwdriver to the left as shown in **Fig. 18** to extract the card name holder;
- Edit the card name then replace it inside the holder and refit: insert the holder inside its housing from the left or right side then push the other side until it clips into place.

Art. 6256 3.5" colour videophone

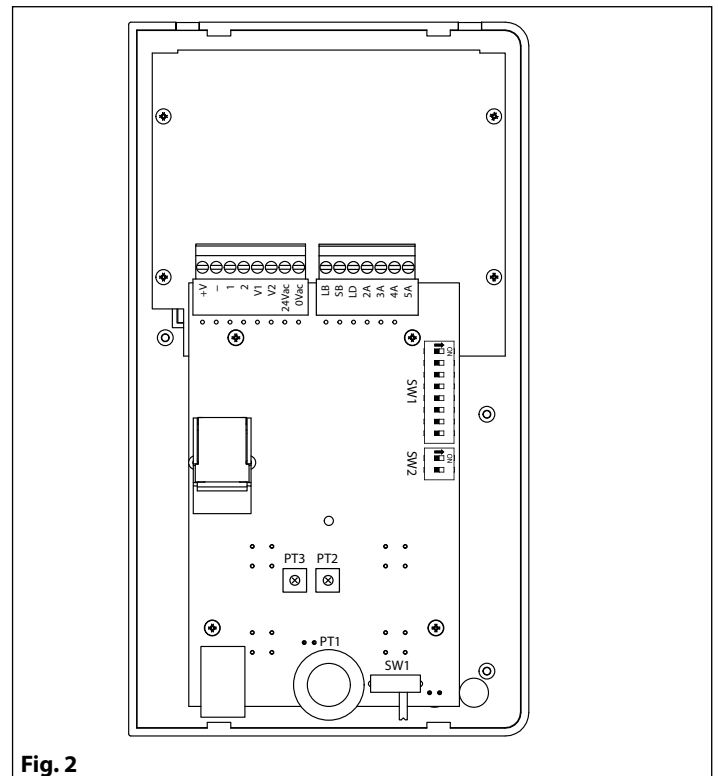
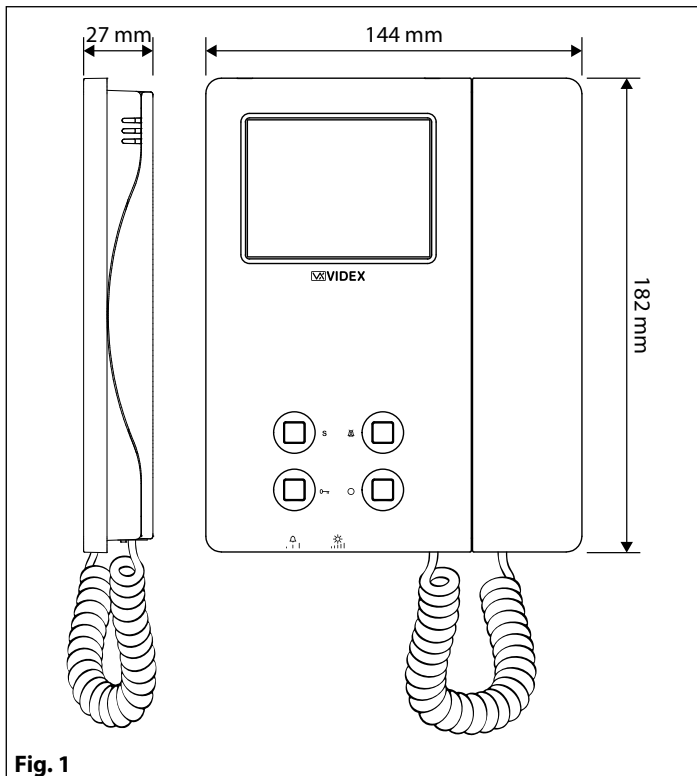



DESCRIPTION



Surface mount videophone incorporating a 3.5" Hi-Res full colour active matrix LCD monitor specific for "6 wire" videokit (VK4K, VRVK and VK8K range). It includes 4 buttons: "camera recall", "open door", "service" and "privacy".

2 LED's* indicate the privacy activated and open door. Programmable privacy duration and number of rings. Intercommunicating call and door call. Adjustments: call tone volume switch (3 levels), picture hue, contrast and brightness.

* The operation of some LED's and the functions described may require additional cabling





PUSH BUTTONS	
S	<p>Service push button. Shorts the "SB" terminal to GROUND (open collector 24Vdc 100mA max) while the button remain pressed.</p>
O	<p>Camera recall button. Pick up the handset then press the button (Press once for door/gate 1, twice for 2 and so on up to a maximum of 4 entrances): the relevant LED switches ON and the monitor switches on showing the video from the door panel. The speech is also live and the door can be opened by pressing O .</p>
Key	<p>Door-open / intercommunicating call button. With the handset lifted and speech lines open to the entrance panel, press this button to open the door. If the terminal "LD" is properly connected the relevant LED remains switched ON until the door is closed. <u>Intercommunication only works when the system is in stand-by condition.</u> Switch 4 of the SW1 dip-switch selects the type of intercommunication: OFF Intercommunication between two apartments - pick up the handset and press the key button to call the videophone(s) in the other apartment. A busy tone will signal that the other videophone is in conversation with the door station and so cannot be called. ON Intercommunication between videophones in the same apartment - pick up the handset and press the key button one, two, three or four times to call videophone with extension address 1, 2, 3 or 4 (Set on dip-switch 2&3 of SW1). <u>Any intercommunicating conversation is always interrupted by an external call (i.e. External calls take priority).</u></p>
⊗	<p>Privacy ON-OFF button. When the system is in stand-by, the pressing of this button activates (LED switched on) or disables (LED switched off) the "privacy" service. The service is automatically disabled when the programmed privacy time expires. When the service is enabled the videophone does not receive calls.</p>

LEDS	
	Door open LED. Can be used to indicate the status of a door or gate. It requires a switched 12Vdc connection to terminal "LD".
	Privacy ON/OFF LED. When the videophone is in stand-by, this LED signals the privacy service status (ON = service enabled, OFF = service disabled).

CONTROLS	
	SW1 Call tone volume controll (3 levels).
	PT1 Brightness control.
PT2	PT2 Hue control.
PT3	PT3 Contrast control.

SETTINGS (DIP-SWITCH)

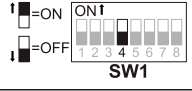
The videophone setup is carried out by the 2 dip-switch banks.

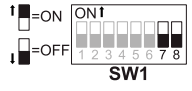
 SW1	Switches 1 Apartment Address OFF 1 ON 2
 SW1	Switches 2,3 Extension Address OFF OFF 1 ON OFF 2 OFF ON 3 ON ON 4
 SW1	Switch 4 Intercommunication OFF Between videophones of the two apartment ON Between videophones in the same apartment
 SW1	Switches 5,6 Number of rings OFF OFF 2 ON OFF 4 OFF ON 6 ON ON 8
 SW1	Switches 7,8 Privacy duration time OFF OFF 15 minutes ON OFF 1 hours OFF ON 4 hours ON ON 8 hours

2 WAY DIP-SWITCH (SW2)

 SW2	<p>The two way dip-switch adjusts the impedance of the video signal. The default setting is "ON" for both switches (75 Ohm): when there are more videophones in parallel connection (without video distributor) both switches must be "ON" only on the last videophone (looking at the connection order) while for all other videophones both switches must be set to "OFF".</p>
--	--

SIGNALS ON CONNECTION BOARD

+V	20Vdc Input/Output (As input 16÷20Vdc 0,5A – as output 20Vdc 0,5A max)
-	Ground reference for +V terminal.
1	Speech line output from handset's microphone and data signal (Approx. 12V in stand-by, 5V during a conversation)
2	Speech line input toward the handset's loudspeaker (Approx. 12V in stand-by, approx. 3V during a conversation)
V1	Balanced video signal 1 sync.-
V2	Balanced video signal 2 sync.+
~	24Vac 1A max power input
~	

LB	Local call input (5V in standby, 0V to trigger)
SB	Service button (open collector) active low output. The button goes active when the button is pressed (Open Collector 24Vdc 100mA max)
LD	12Vdc input for door-open LED
2A	Speech line input toward the loudspeaker of the parallel telephone (Approx. 12V in stand-by, 3V during a conversation)
3A	Output switched ground for parallel telephone
4A	Output call tone for parallel telephone
5A	Input for door-open command from parallel telephone

TECHNICAL SPECIFICATION

Power Supply:	Supplied by the BUS line, 20Vdc
Power consumption:	Stand-by: 50mA Max Operating: 200mA Max
Working Temperature:	-10 +50 °C

6200 Series Videophone wall mounting instructions

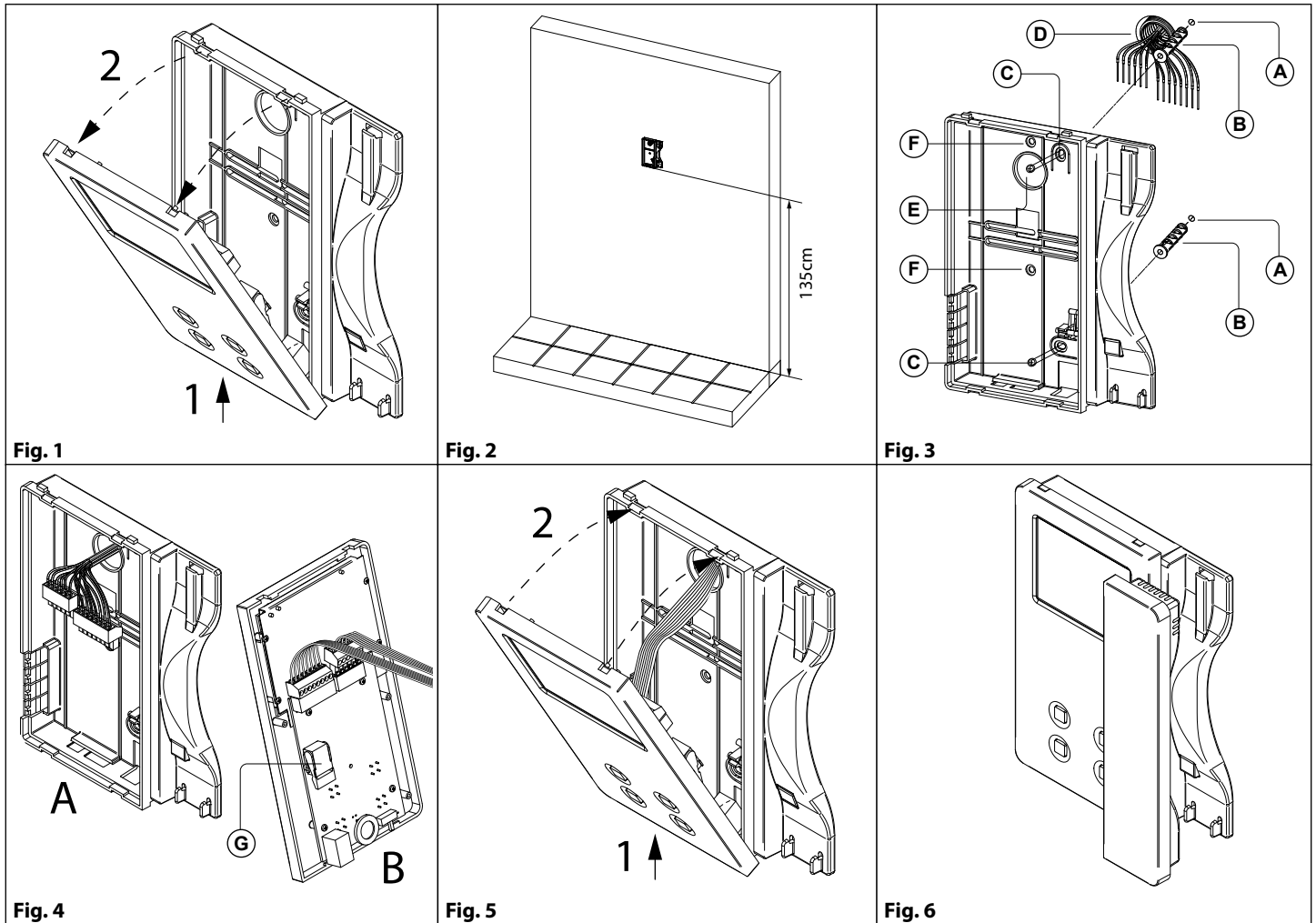

1. In order to install the videophone, it is necessary to remove the cover, which contains all the electronics, from the base: firstly disconnect the handset from the videophone (by removing its plug from the videophone), then press lightly the bottom part of the videophone and simultaneously pulling outwards the upper part as shown in **Fig. 1**.
2. Put the base of the unit on the wall at approx 135cm from the finished floor to mark the points for the fixing holes "A" (**Fig. 2**) remembering that the wires "D" (**Fig. 3**) must be fed through the hole "E" (**Fig. 3**). If you use the flush mounting box 503, embed it into the wall vertically at approx. 140cm from the finished floor and the base.
3. Following **Fig. 3**, make the holes "A", insert the wall plugs "B" and fix the base with the screws "C" feeding the wires "D" into the hole "E". If you have used the box 503, fix the base to the wall through the holes "F" using the screws "C".
4. As shown in **Fig. 4A**, connect the wires to the removable terminals following the provided installation diagram. Connect the terminal blocks to the electronics contained in the cover as shown in **Fig. 4B**. Reinsert the handset and test system before closing. **Note: Contrast and hue trimmers can be adjusted only if the videophone is open. Note while testing the system, it is advisable to hold the cover with your hand closing manually the hook switch of the handset (see Fig. 4B reference "G").**
5. Once testing is complete and all the necessary adjustments are made, disconnect the handset from the cover and close the unit as shown in **Fig. 5**: first hook it on the bottom then push in the top until you hear the clip.
6. Reconnect the handset and hang it as shown in **Fig. 6**.

Installation diagrams

NOTES AND SUGGESTIONS

- All diagrams refer to all kits versions: flush or surface, colour or black & white.
- Dashed connections refer to optional connections ("Local bell", "Push to exit" & "Door monitor").
- Some diagrams show how to connect a 12Vdc electric lock: these directions are suitable for all diagrams in this manual.
- Each time a setting is changed on a videophone (address, extension, number of rings etc.), the videophone must be disconnected from the relevant connection board then after a few seconds reconnected again to allow the recognizing of the new setting.
- All diagrams shown are valid for B&W or colour systems with surface or flush mount door station.

DECLARATION OF RESPONSIBILITY

This manual has been written and revised carefully. The instructions and the descriptions which are included in it are referred to VIDEX parts and are correct at the time of print. However, subsequent VIDEX parts and manuals, can be subject to changes without notice. VIDEX Electronics S.p.A. cannot be held responsible for damages caused directly or indirectly by errors, omissions or discrepancies between the VIDEX parts and the Manual.



WE RECOMMEND

This equipment is installed by a Competent Electrician, Security on Communications Engineer

VIDEOKIT VK4K-1/6256, VK4K-1S/6256

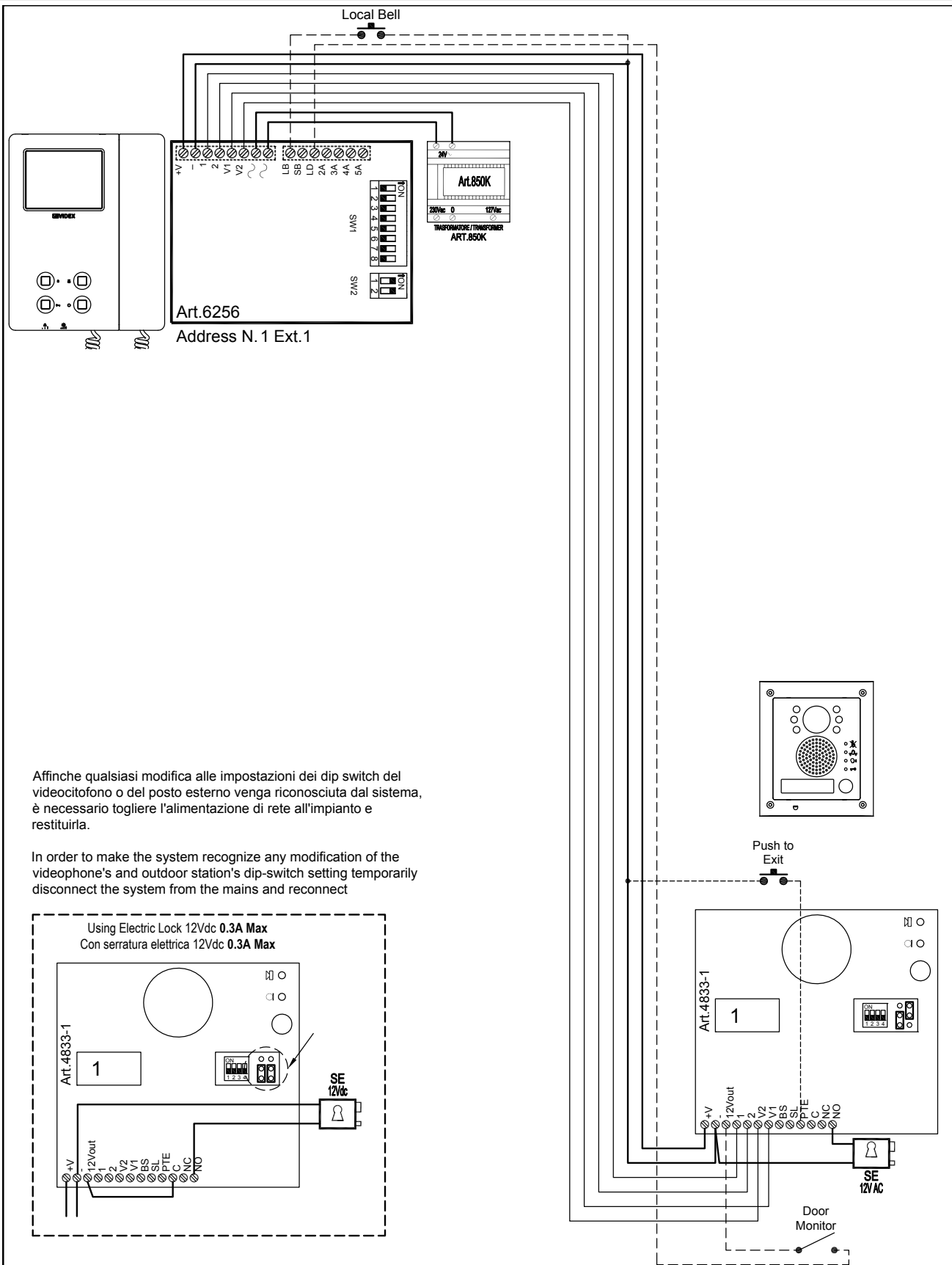

Affinche qualsiasi modifica alle impostazioni dei dip switch del videocitofono o del posto esterno venga riconosciuta dal sistema, è necessario togliere l'alimentazione di rete all'impianto e restituirla.

In order to make the system recognize any modification of the videophone's and outdoor station's dip-switch setting temporarily disconnect the system from the mains and reconnect

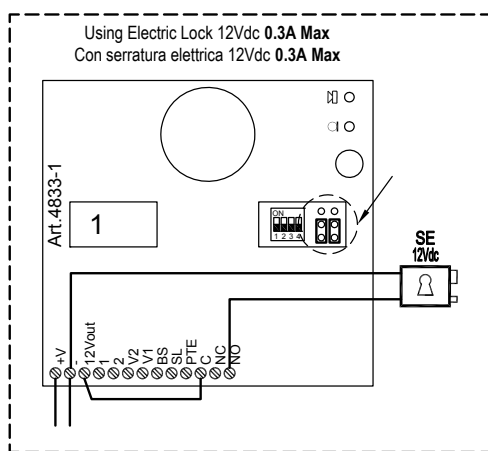

Titolo: VK4K-1/6256, VK4K-1S/6256		Data creazione: 23/10/2015	Foglio 1 / 1
Titolo: VK4K-1/6256, VK4K-1S/6256		Data modifica: 18/11/2015	
Videx Electronics S.p.A. Via del Lavoro 1, 63020 Monte Giberto (AP) Phone: +39 0734 631669 - Fax: +39 0734 631669 www.videx.it - info@videx.it		Autore: Marco Rongoni Cod. File: vk4k62h-002.dwg	

VK4K/6256 Series "6 wire Bus" videokit Installation diagrams

VIDEOKIT VK4K-2/6256, VK4K-2S/6256

Affinche qualsiasi modifica alle impostazioni dei dip switch del videocitofono o del posto esterno venga riconosciuta dal sistema, è necessario togliere l'alimentazione di rete all'impianto e restituirlo.

In order to make the system recognize any modification of the videophone's and outdoor station's dip-switch setting temporarily disconnect the system from the mains and reconnect

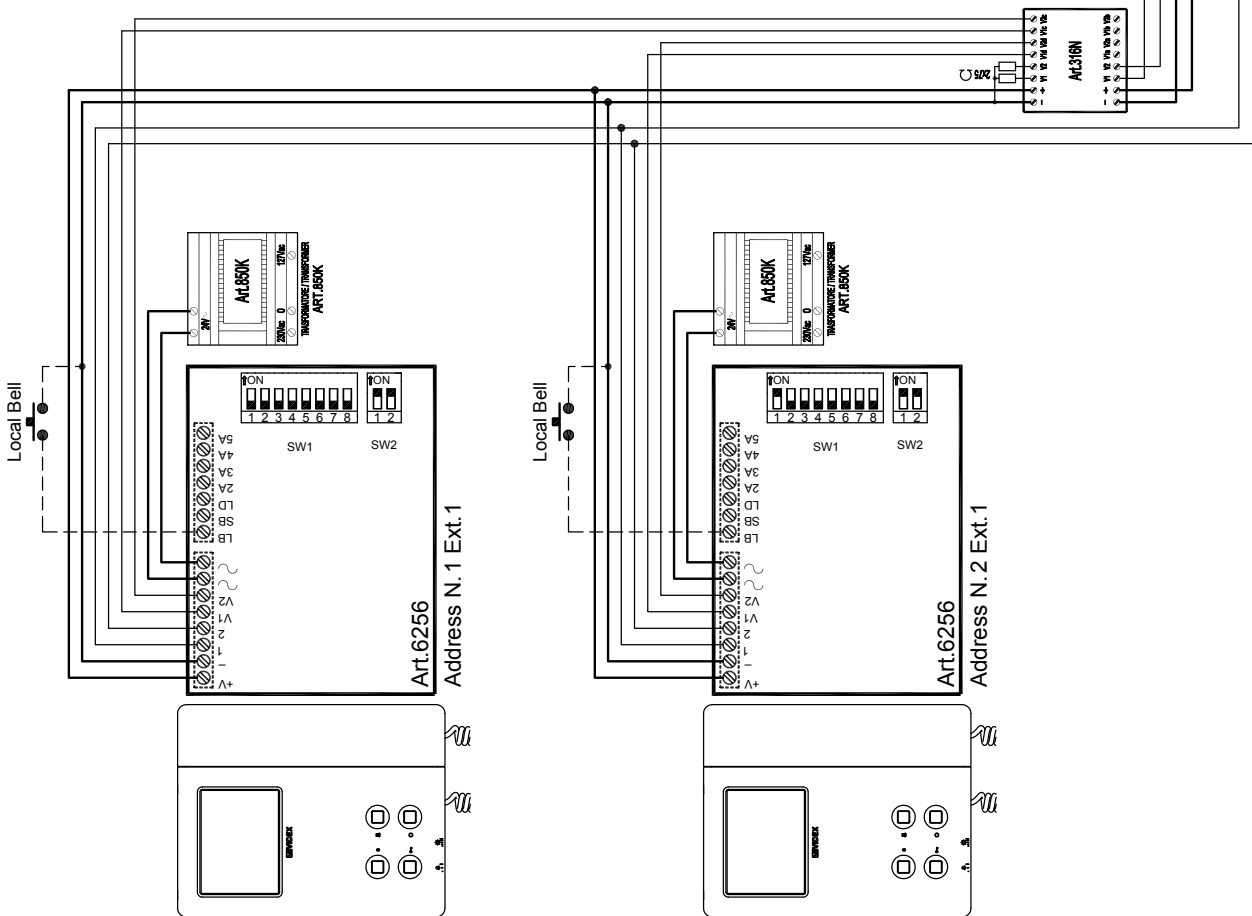
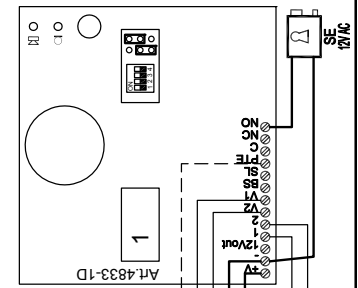
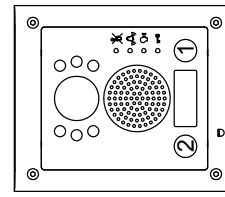
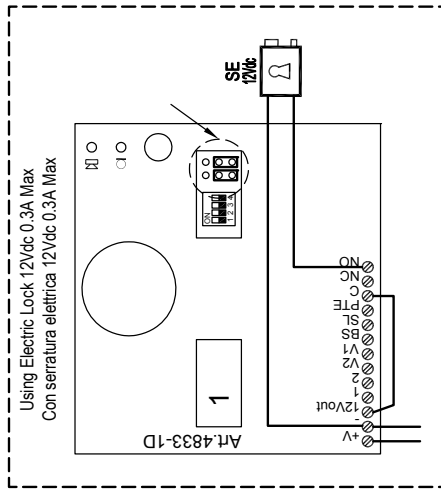

Title: VK4K-2/6256, VK4K-2S/6256

Date creazione: 17/11/2015

Foglio 1 / 1

Title: VK4K-2/6256, VK4K-2S/6256

Data modifica: 18/11/2015



Videx Electronics S.p.A.
Via del Lavoro 1, 63020 Monte Giberto (AP)
Phone: +39 0734 631869 - Fax: +39 0734 631869
www.videx.it - info@videx.it

Notes:

Note:

Autore:
Marco Rongoni
Cod.File:
vk4k62h-003.dwg

VIDEOKIT VK4KC-1/6256, VK4KC-1S/6256

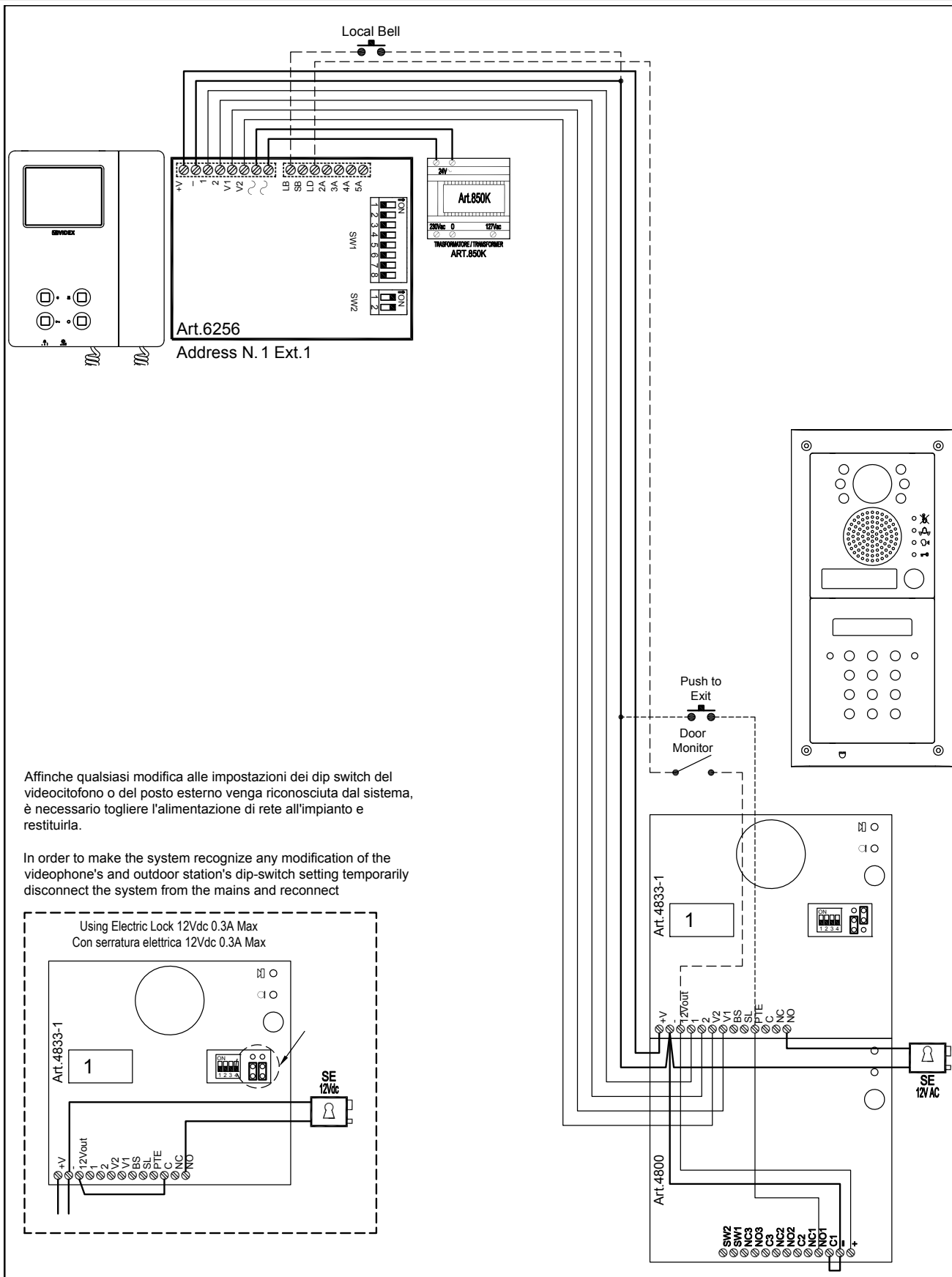

Affinche qualsiasi modifica alle impostazioni dei dip switch del videocitofono o del posto esterno venga riconosciuta dal sistema, è necessario togliere l'alimentazione di rete all'impianto e restituirla.

In order to make the system recognize any modification of the videophone's and outdoor station's dip-switch setting temporarily disconnect the system from the mains and reconnect

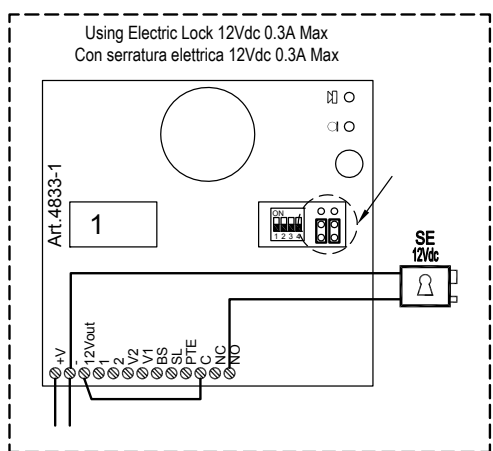

Title: VK4KC-1/6256, VK4KC-1S/6256		Date creazione: 17/11/2015	Foglio 1 / 1
Title: VK4KC-1/6256, VK4KC-1S/6256		Data modifica: 17/11/2015	
Videx Electronics S.p.A. Via del Lavoro 1, 63020 Monte Giberto (AP) Phone: +39 0734 631669 - Fax: +39 0734 631669 www.videx.it - info@videx.it	Notes: — — —	Autore: Marco Ronconi Cod. File: vk4k62h-004.dwg	

VIDEOKIT VK4KC-2/6256, VK4KC-2S/6256

Affinche qualsiasi modifica alle impostazioni dei dip switch del videocitofono o del posto esterno venga riconosciuta dal sistema, è necessario togliere l'alimentazione di rete all'impianto e restituirla.

In order to make the system recognize any modification of the videophone's and outdoor station's dip-switch setting temporarily disconnect the system from the mains and reconnect

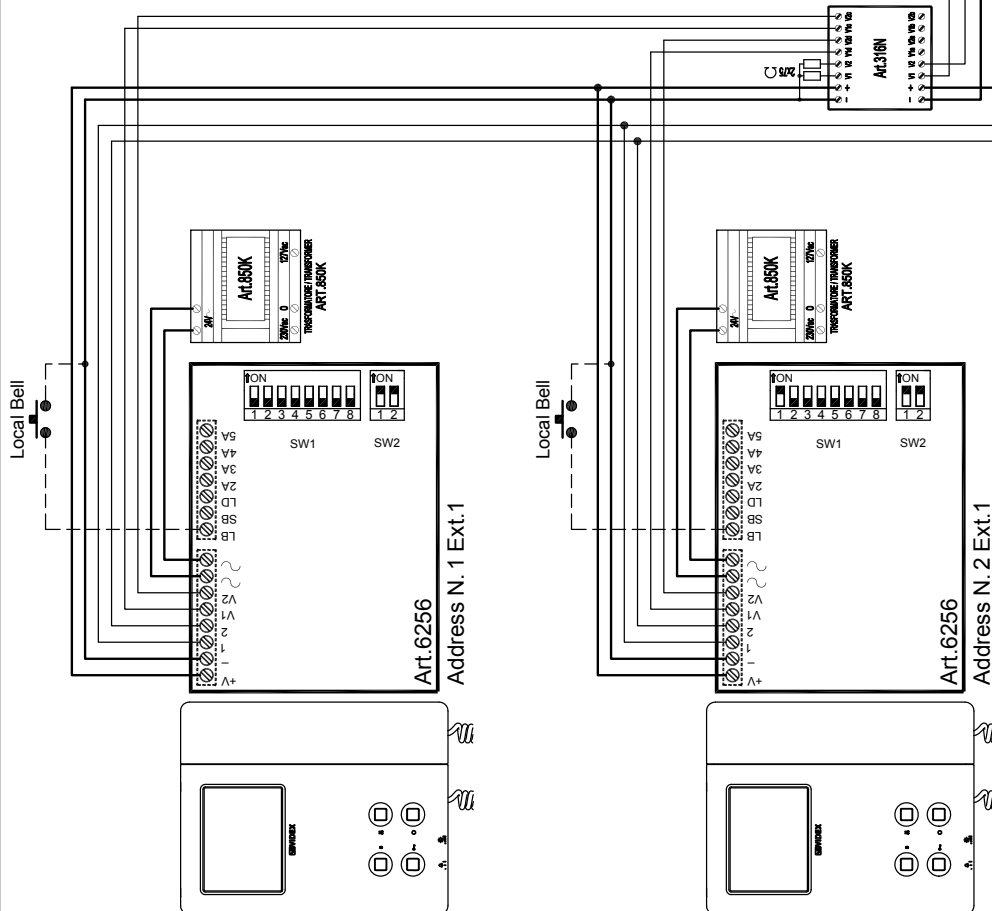
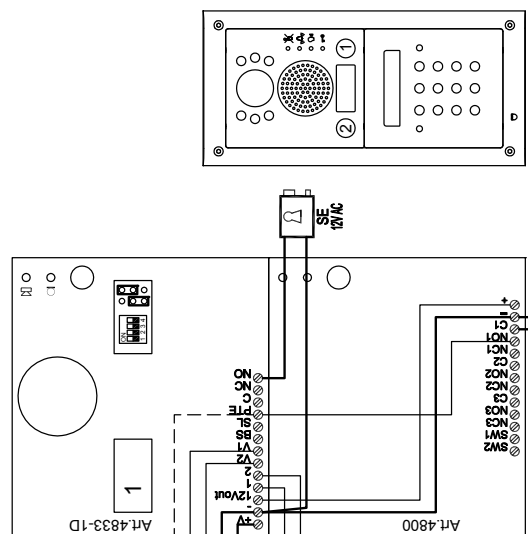
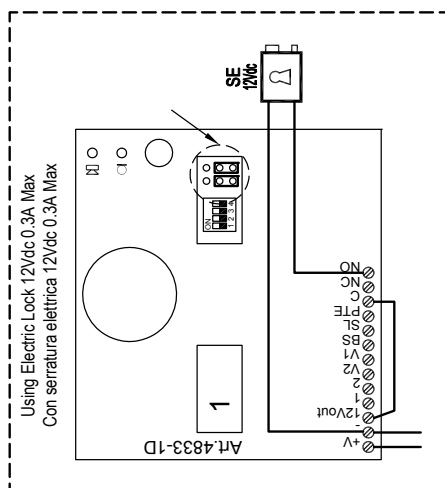

Titolo:
VK4KC-2/6256, VK4KC-2S/6256

Data creazione:
17/11/2015

Foglio
1 / 1

Thema:
VK4KC-2/6256, VK4KC-2S/6256

Data modifica:
17/11/2015

 Videx Electronics S.p.A.
Via del Lavoro 1, 63020 Monte Giberto (AP)
Phone: +39 0734 631689 - Fax: +39 0734 631689
www.videx.it - info@videx.it

Notes:
—
Note:
—

Autore:
Marco Rongoni
Cod.Fil:
vk4k62h-005.dwg

VIDEOKIT VK4K-1/6256, VK4K-1S/6256 WITH ADDITIONAL INTERCOM AND EXTENSION SOUNDER

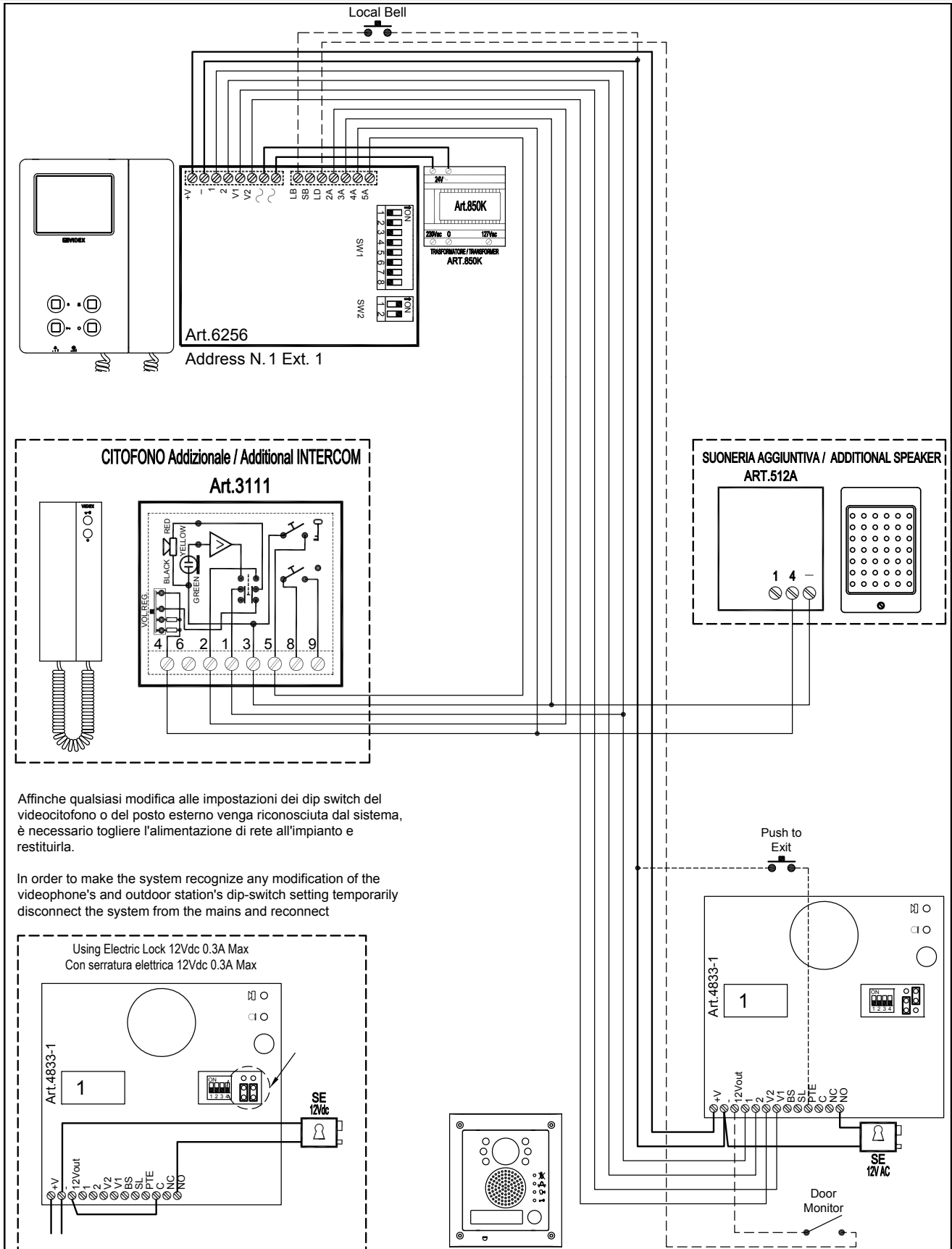

Affinche qualsiasi modifica alle impostazioni dei dip switch del videocitofono o del posto esterno venga riconosciuta dal sistema, è necessario togliere l'alimentazione di rete all'impianto e restituirla.

In order to make the system recognize any modification of the videophone's and outdoor station's dip-switch setting temporarily disconnect the system from the mains and reconnect

Using Electric Lock 12Vdc 0.3A Max
 Con serratura elettrica 12Vdc 0.3A Max

Titolo: VK4K-1/6256, VK4K-1S/6256 plus Additional handset and additional speaker.		Data creazione: 17/11/2015	Foglio 1 / 1
Titolo: VK4K-1/6256, VK4K-1S/6256 plus Additional handset and additional speaker.		Data modifica: 17/11/2015	
Notes: Videx Electronics S.p.A. Via del Lavoro 1, 63020 Monte Giberto (AP) Phone: +39 0734 631669 - Fax: +39 0734 631669 www.videx.it - info@videx.it		Autore: Marco Rongoni Cod.Filer: vk4k62h-008.dwg	

VIDEOKIT VK4K-1/6256, VK4K-1S/6256 WITH ADDITIONAL DOOR PANEL FOR 2 ENTRANCES SYSTEM

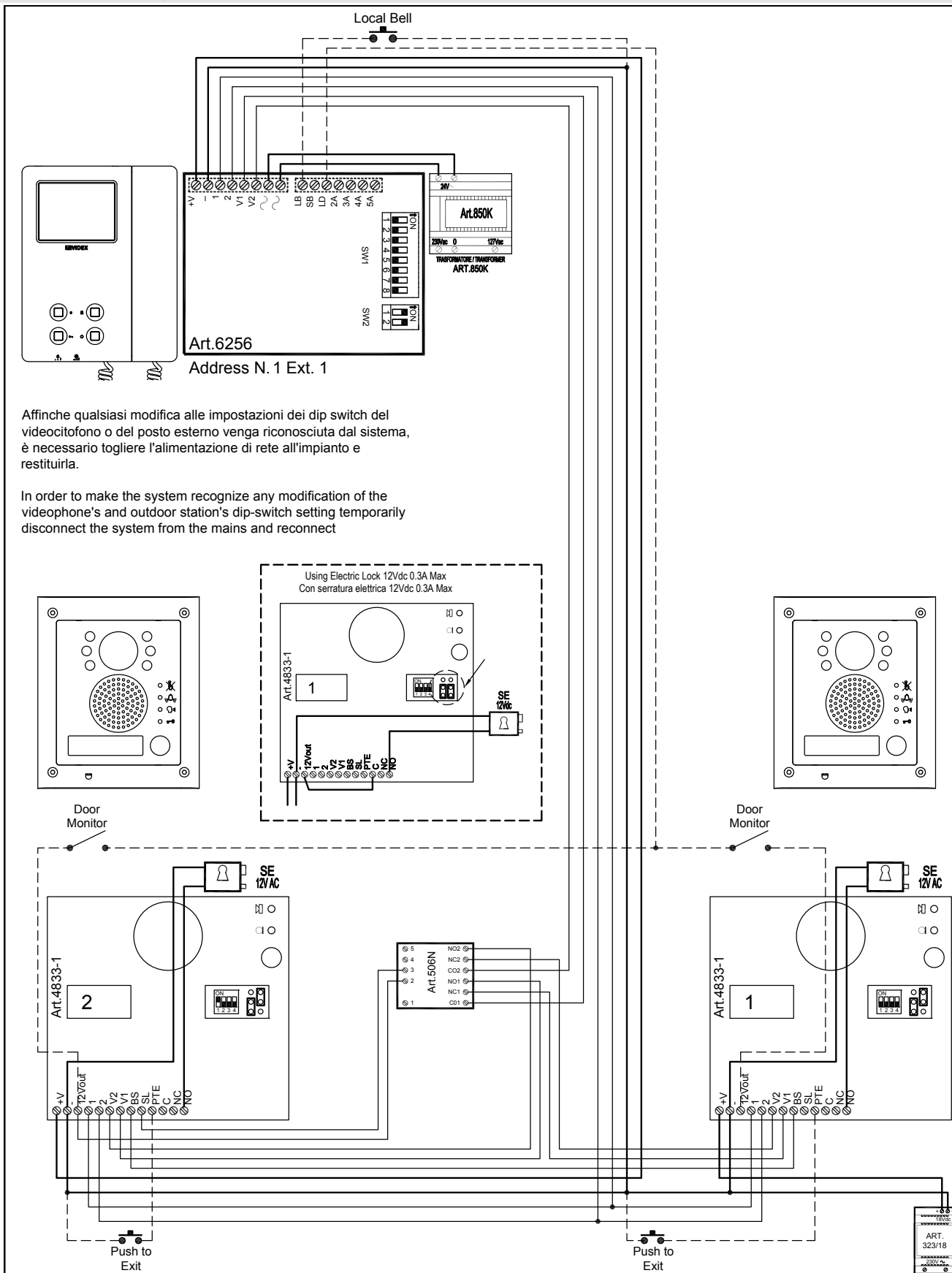

Affinche qualsiasi modifica alle impostazioni dei dip switch del videocitofono o del posto esterno venga riconosciuta dal sistema, è necessario togliere l'alimentazione di rete all'impianto e restituirla.

In order to make the system recognize any modification of the videophone's and outdoor station's dip-switch setting temporarily disconnect the system from the mains and reconnect

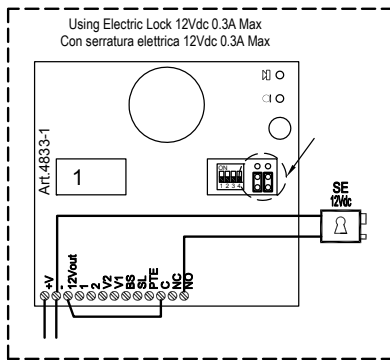

Title: VK4K-1, VK4K-1S with second door panel for two entrances system		Data creazione: 17/11/2015	Foglio 1 / 1
Titolo: VK4K-1, VK4K-1S con secondo posto esterno per un sistema a due ingressi		Data modifica: 17/11/2015	
Notes: Videx Electronics S.p.A. Via del Lavoro 1, 63020 Monte Giberto (AP) Phone: +39 0734 631669 - Fax: +39 0734 631669 www.videx.it - info@videx.it		Autore: Marco Rongoni Cod File: vk4k62h-009.dwg	

VIDEOKIT VK4KC-1/4900/6256 - VK4KC-1S/4900/6256 WITH 3 ADDITIONAL VIDEOPHONES

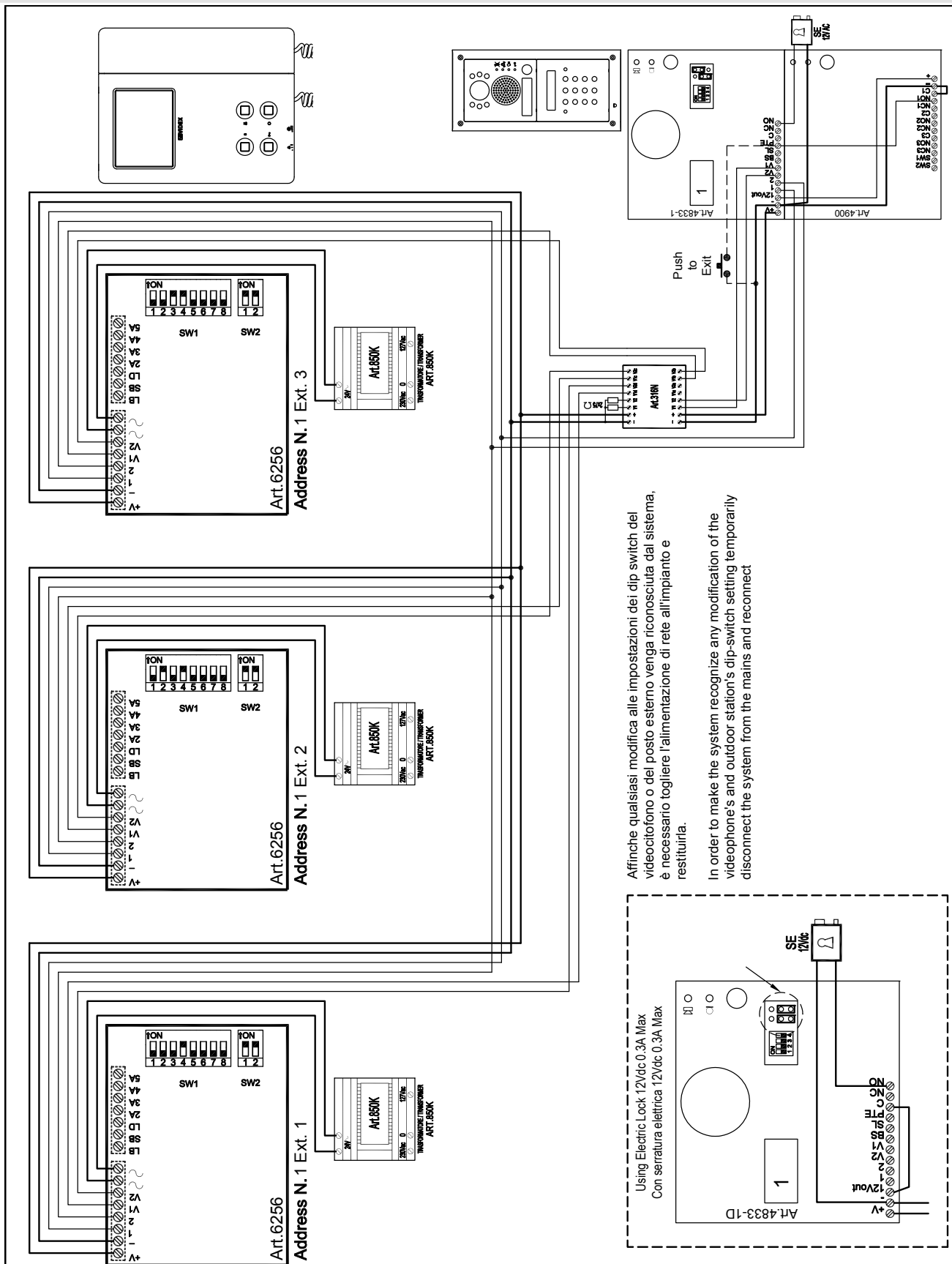

Affinche qualsiasi modifica alle impostazioni dei dip switch del videocitofono o del posto esterno venga riconosciuta dal sistema, è necessario togliere l'alimentazione di rete all'impianto e restituirlo.

In order to make the system recognize any modification of the videophone's and outdoor station's dip-switch setting temporarily disconnect the system from the mains and reconnect

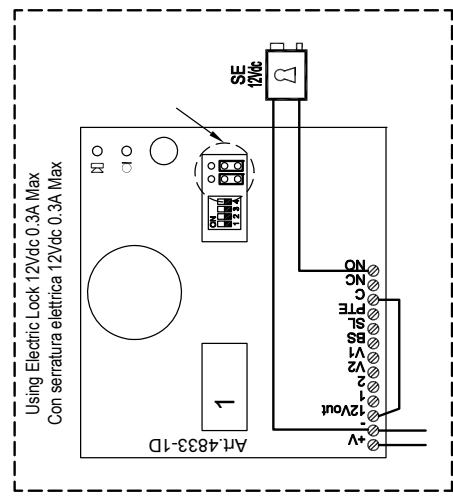

Titolo: VK4KC-1/6256/4900, VK4KC-1S/6256/4900 + 2 additional videophones & Codelock unit Art.4900		Data creazione:	17/11/2015	Foglio	1 / 1
Titolo: VK4KC-1/6256/4900, VK4KC-1S/6256/4900 + 2 videocitofoni addizionali & tastiera digitale Art.4900		Data modifica:	17/11/2015		
Videa Electronics S.p.A. Via del Lavoro 1, 63020 Monte Giberto (AP) Phone: +39 0734 631669 - Fax +39 0734 631669 www.videx.it - info@videx.it		Note: L'indirizzo di appartamento è lo stesso per tutti i videocitofoni mentre cambia l'indirizzo di interno		Autore: Marco Rongoni Cod. File: vk4k62h-010.dwg	

VIDEOKIT VK4K-1/6256 - VK4K-1S/6256 WITH EXTERNAL CAMERA CONTROLLED BY SERVICE PUSH BUTTON

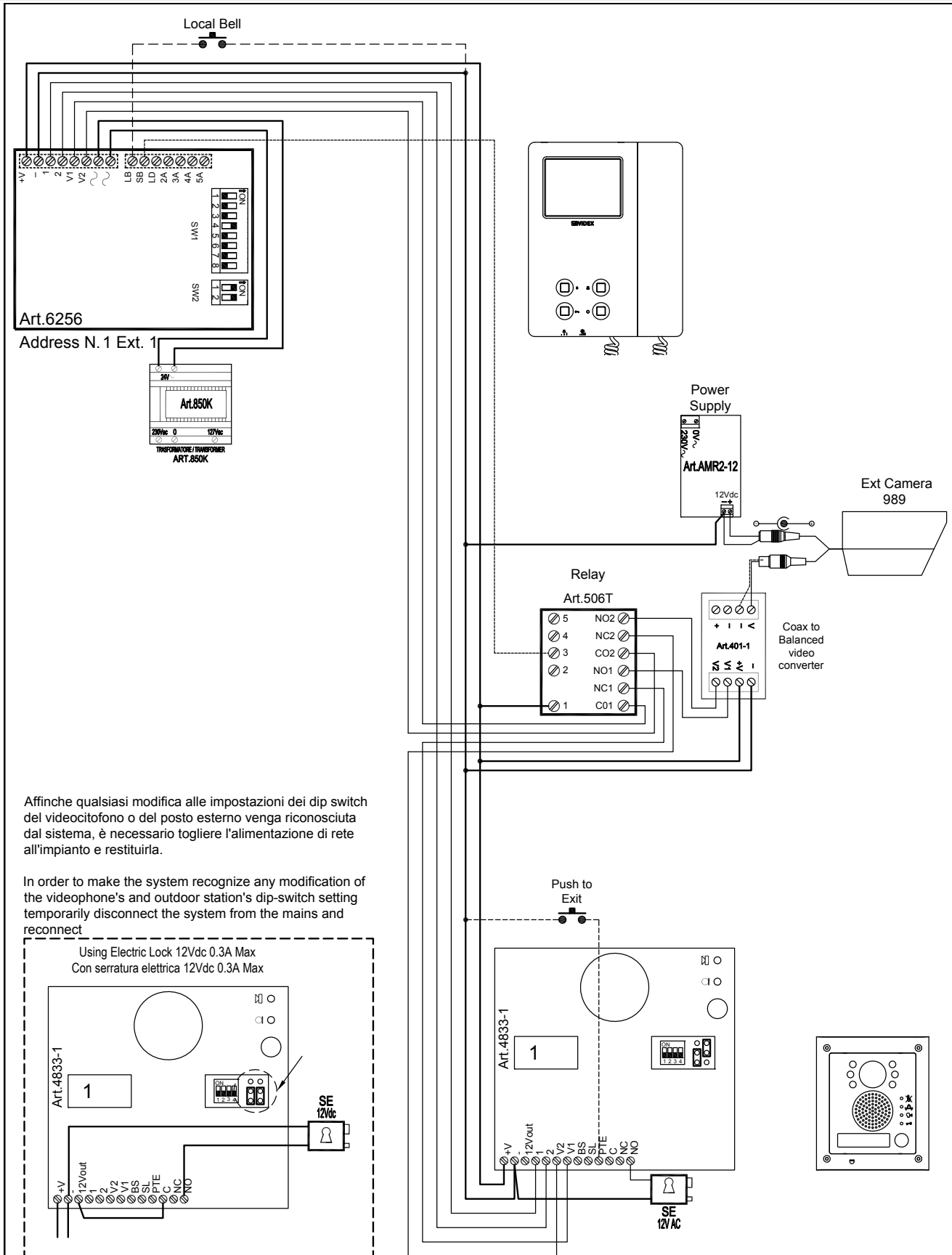

Affinche qualsiasi modifica alle impostazioni dei dip switch del videocitofono o del posto esterno venga riconosciuta dal sistema, è necessario togliere l'alimentazione di rete all'impianto e restituirla.

In order to make the system recognize any modification of the videophone's and outdoor station's dip-switch setting temporarily disconnect the system from the mains and reconnect

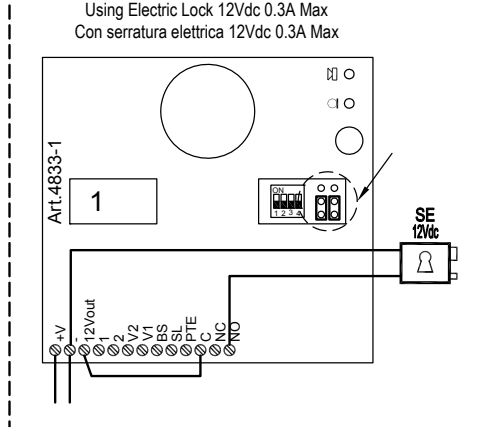

Titolo: VK4K-1, VK4K-1S with additional external camera		Data creazione: 17/11/2015	Foglio 1 / 1
Titolo: VK4K-1, VK4K-1S con telecamera esterna addizionale		Data modifica: 17/11/2015	
 Videx Electronics S.p.A. Via del Lavoro 1, 63020 Monte Giberto (AP) Phone: +39 0734 631669 - Fax: +39 0734 631669 www.videx.it - info@videx.it		Autore: Marco Rongoni Cod.Filer: vk4k62h-011.dwg	

VIDEOKIT VK4KC-1/6256 - VK4KC-1S/6256 WITH ADDITIONAL VIDEOPHONE

Affinche qualsiasi modifica alle impostazioni dei dip switch del videocitofono o del posto esterno venga riconosciuta dal sistema, è necessario togliere l'alimentazione di rete all'impianto e restituirlo.

In order to make the system recognize any modification of the videophone's and outdoor station's dip-switch setting temporarily disconnect the system from the mains and reconnect

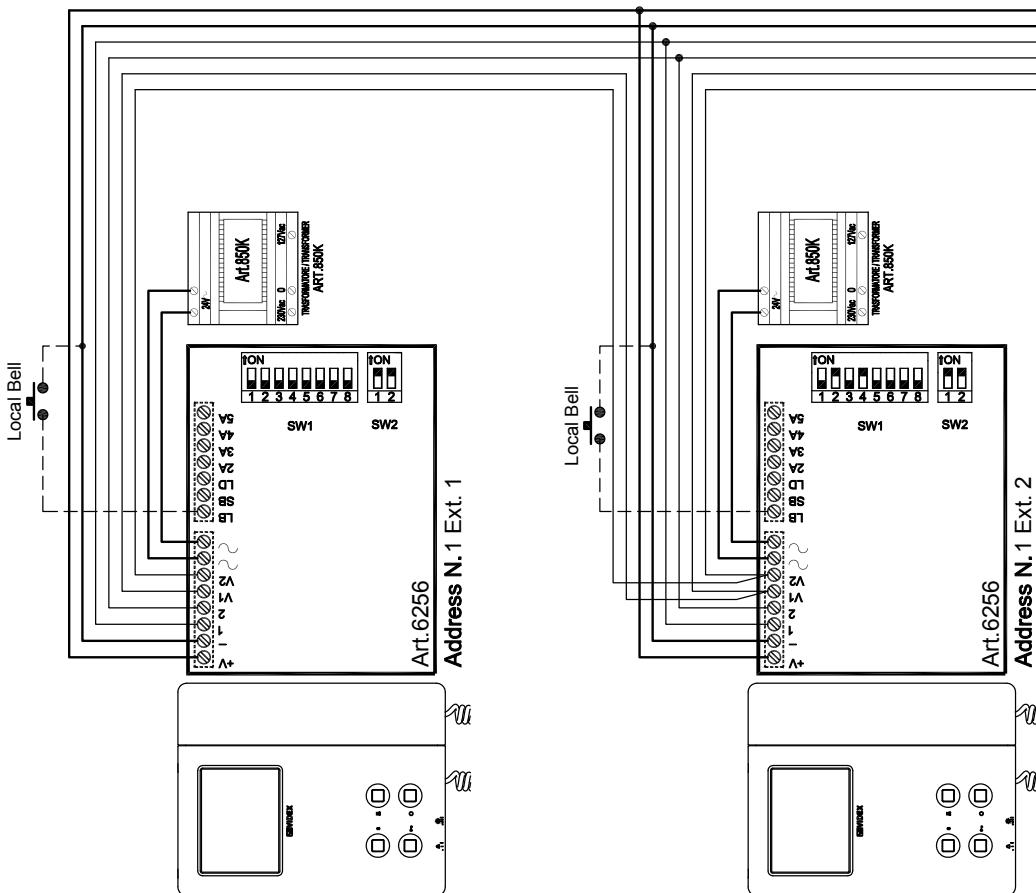
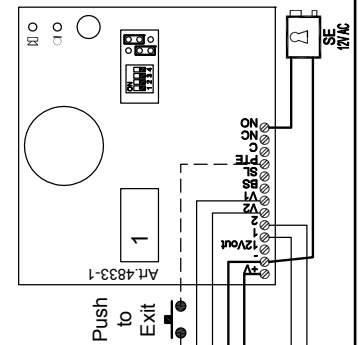
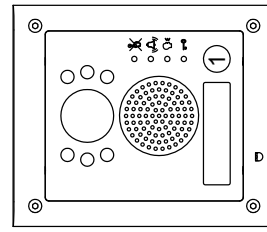
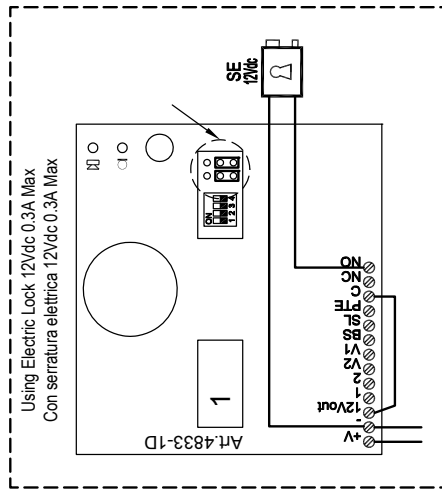

Titolo: VK4K-1/6256, VK4K-1S/6256 with additional videophone without video distributor

Data creazione: 17/11/2015 Foglio 1 / 1

Titolo: VK4K-1/6256, VK4K-1S/6256 con videocitofono addizionale senza distributore video

Data modifica: 18/11/2015

Videx Electronics S.p.A.
 Via del Lavoro 1, 63020 Monte Giberto (AP)
 Phone: +39 0734 631669 - Fax: +39 0734 631669
 www.videx.it - info@videx.it

Notes:

 Note:

Autore: Marco Rongoni
 Cod.Filer: vk4k62h-012.dwg

VK4K/6256 Series "6 wire Bus" videokit Installation diagrams

VIDEOKIT VK4K-2/6256 - VK4K-2S/6256 WITH ART. 316

Affinche qualsiasi modifica alle impostazioni dei dip switch del videocitofono o del posto esterno venga riconosciuta dal sistema, è necessario togliere l'alimentazione di rete all'impianto e restituirlo.

In order to make the system recognize any modification of the videophone's and outdoor station's dip-switch setting temporarily disconnect the system from the mains and reconnect

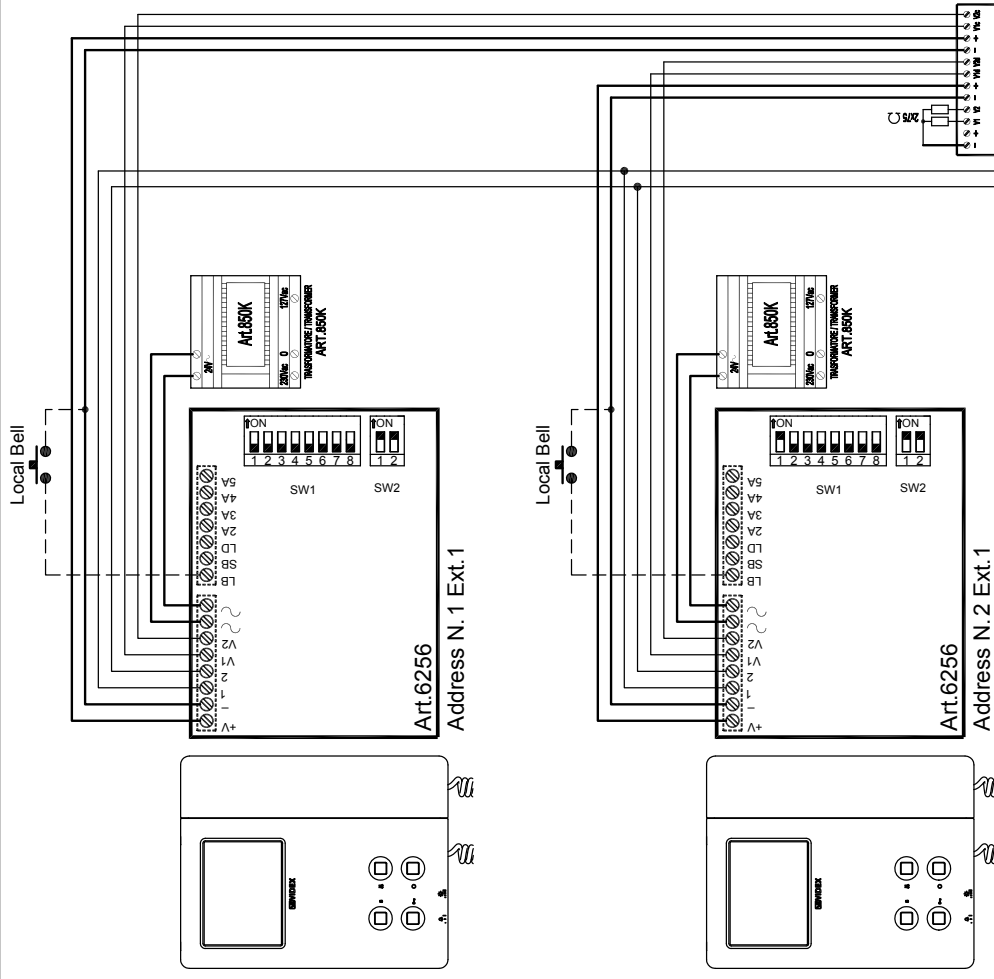
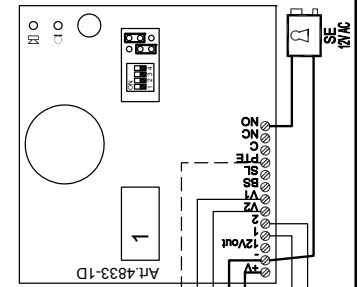
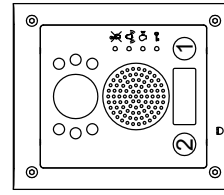
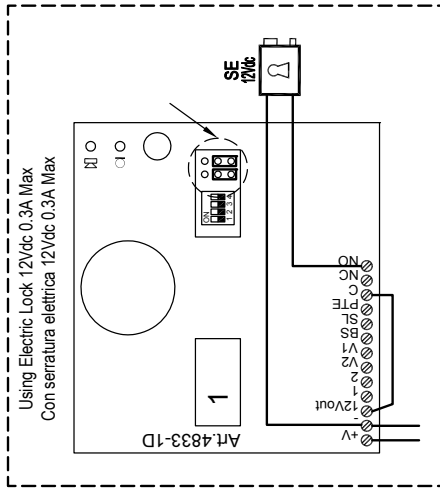

Titolo: VK4K-2/6256, VK4K-2S/6256		Data creazione: 21/10/2015	Foglio 1 / 1
Titolo: VK4K-2/6256, VK4K-2S/6256		Data modifica: 17/11/2015	
Videx Electronics S.p.A. Via del Lavoro 1, 62020 Monte Giberto (AP) Phone: +39 0734 631889 - Fax: +39 0734 631889 www.videx.it - info@videx.it		Autore: Marco Rongoni Cod. File: vk4k62h-001.dwg	

TWO ENTRANCES SYSTEM INSTALLATION

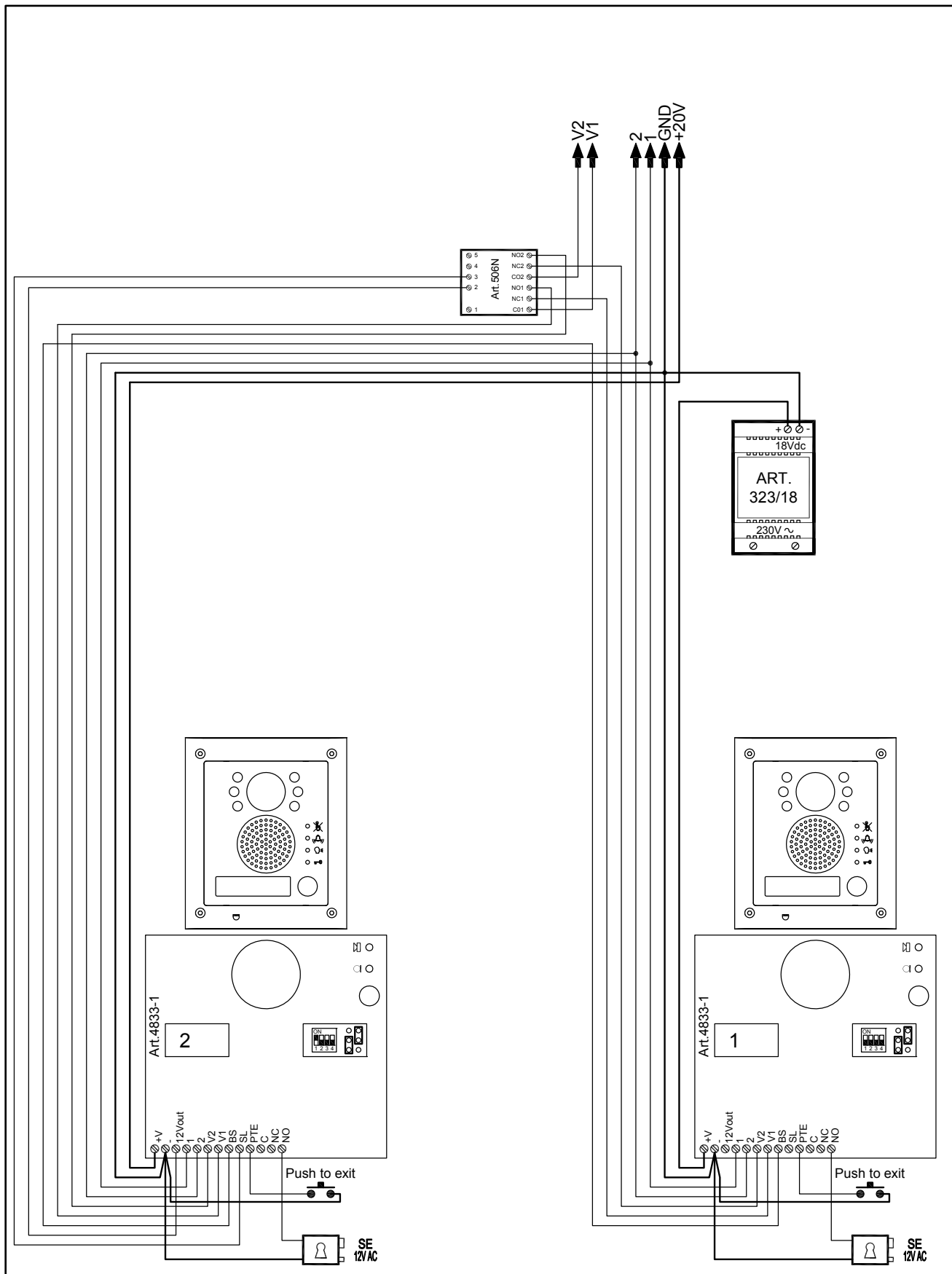

Titolo: VK4K-1, VK4K-1S with second door panel for two entrances system		Data creazione: 29/10/2015	Foglio 1 / 1
Titolo: VK4K-1, VK4K-1S con secondo posto esterno per un sistema a due ingressi		Data modifica: 29/10/2015	
Notes: --- Note: ---		Autore: Marco Ronconi	
Via del Lavoro 1, 63846 Monte Giberto (FM) Phone: +39 0734 631669 - Fax +39 0734 631669 www.videx.it - info@videx.it		Cod File: vk4k-1-001-2e.dwg	

FOUR ENTRANCES SYSTEM INSTALLATION

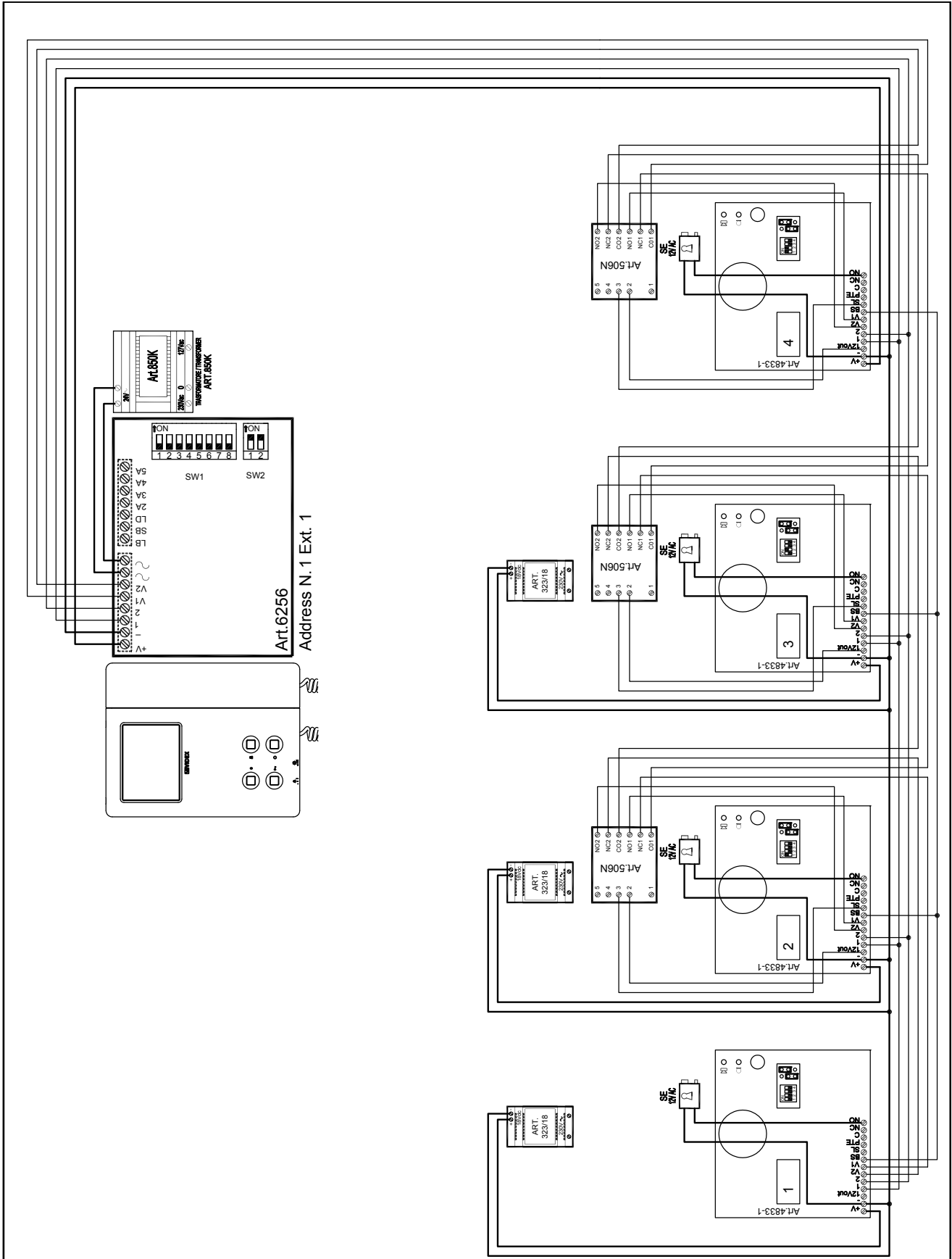

Title: VK4K-1/6256, VK4K-1S/6256 with 3 additional door panels for four entrances system
 Thico: VK4K-1/6256, VK4K-1S/6256 con 3 posti esterni addizionali un sistema a 4 ingressi
Videx Electronics S.p.A.
 Via del Lavoro 1, 63020 Monte Giberto (AP)
 Phone: +39 0734 631689 - Fax: +39 0734 631689
 www.videx.it - info@videx.it

Data creazione: 25/11/2015
 Data modifica: 25/11/2015
 Autore: Marco Rongoni
 Cod.File: vk4k62h-013.dwg



THE POWER TO SECURE



made in
ITALY

MANUFACTURER

VIDEX ELECTRONICS S.P.A.

Via del Lavoro, 1 - 63846 Monte Giberto (FM) Italy
Tel (+39) 0734 631669 - Fax (+39) 0734 632475
www.videx.it - info@videx.it

CUSTOMER SUPPORT

All Countries:

VIDEX ELECTRONICS S.P.A.

www.videx.it - technical@videx.it
Tel: +39 0734-631669 - Fax: +39 0734-632475

UK Customers:

VIDEX SECURITY LTD

www.videx-security.com
Tech Line: 0191 224 3174 - Fax: 0191 224 1559

Main UK office:

VIDEX SECURITY LTD

1 Osprey Trinity Park
Trinity Way
LONDON E4 8TD
Phone: (+44) 0870 300 1240
Fax: (+44) 020 8523 5825
www.videx-security.com
marketing@videx-security.com

Northern UK office:

VIDEX SECURITY LTD

Unit 4-7
Chillingham Industrial Estate
Chapman Street
NEWCASTLE UPON TYNE - NE6 2XX
Tech Line: (+44) 0191 224 3174
Phone: (+44) 0870 300 1240
Fax: (+44) 0191 224 1559

Greece office:

VIDEX HELLAS Electronics

48 Filolaou Str.
11633 ATHENS
Phone: (+30) 210 7521028
(+30) 210 7521998
Fax: (+30) 210 7560712
www.videx.gr
videx@videx.gr

Danish office:

VIDEX DANMARK

Hammershusgade 15
DK-2100 COPENHAGEN
Phone: (+45) 39 29 80 00
Fax: (+45) 39 27 77 75
www.videx.dk
videx@videx.dk

Benelux office:

NESTOR COMPANY NV

E3 laan, 93
B-9800 Deinze
Phone: (+32) 9 380 40 20
Fax: (+32) 9 380 40 25
www.videx.be
info@videx.be

Dutch office:

NESTOR COMPANY BV

Business Center Twente (BCT)
Grotestraat, 64
NL-7622 GM Borne
www.videxintercom.nl
info@videxintercom.nl



The product is CE marked demonstrating its conformity and is for distribution within all member states of the EU with no restrictions. This product follows the provisions of the European Directives 2014/30/EU (EMC); 2014/35/EU (LVD); 2011/65/EU (RoHS): CE marking 93/68/EEC.