

VIDEOKIT

VK4K/6758 SERIES

"6 Wire" bus one way, two way videokit

VK4K

VK4KX

VK4KC

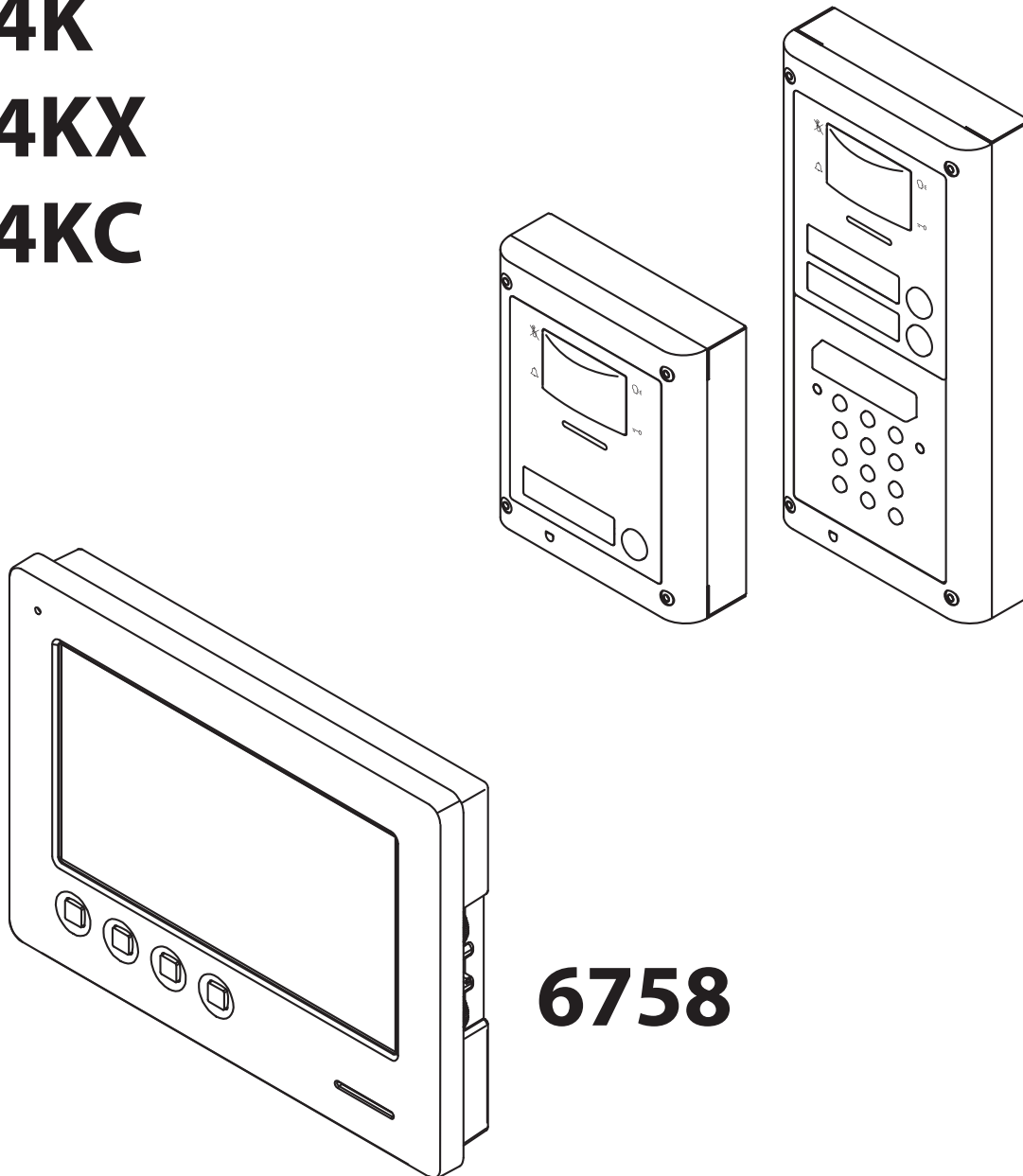

6758

Installation handbook



Index

Introduction	2
System components and available versions	3
General directions for installation	6
Troubleshooting guide	7
Art. 4833/4833X Speaker unit	8
Art. 4800 - 4800M Digital codelock module	14
4000 Series surface and flush mounting door station installation	17
Art. 6758 7" hands free colour display digital videophone	19
6700 Series Videophone wall mounting instructions	22
Art. 316 - Art. 316N 4 Way video distributor for system with balanced video signal	23
Installation diagrams	24

NOTES AND SUGGESTIONS

- All diagrams refer to all kits versions: flush or surface.
- Dashed connections refer to optional connections ("Local bell", "Push to exit" & "Door monitor").
- Some diagrams show how to connect a 12Vdc electric lock: these directions are suitable for all diagrams in this manual.
- Each time a setting is changed on a videophone (address, extension, number of rings etc.), the videophone must be disconnected from the relevant connection board then after a few seconds reconnected again to allow the recognizing of the new setting.

DECLARATION OF RESPONSIBILITY

This manual has been written and revised carefully. The instructions and the descriptions which are included in it are referred to VIDEX parts and are correct at the time of print. However, subsequent VIDEX parts and manuals, can be subject to changes without notice. VIDEX Electronics S.p.A. cannot be held responsible for damages caused directly or indirectly by errors, omissions or discrepancies between the VIDEX parts and the Manual.



WE RECOMMEND

This equipment is installed by a Competent Electrician, Security on Communications Engineer

System components and available versions

VK4K/6758 Colour videokit.

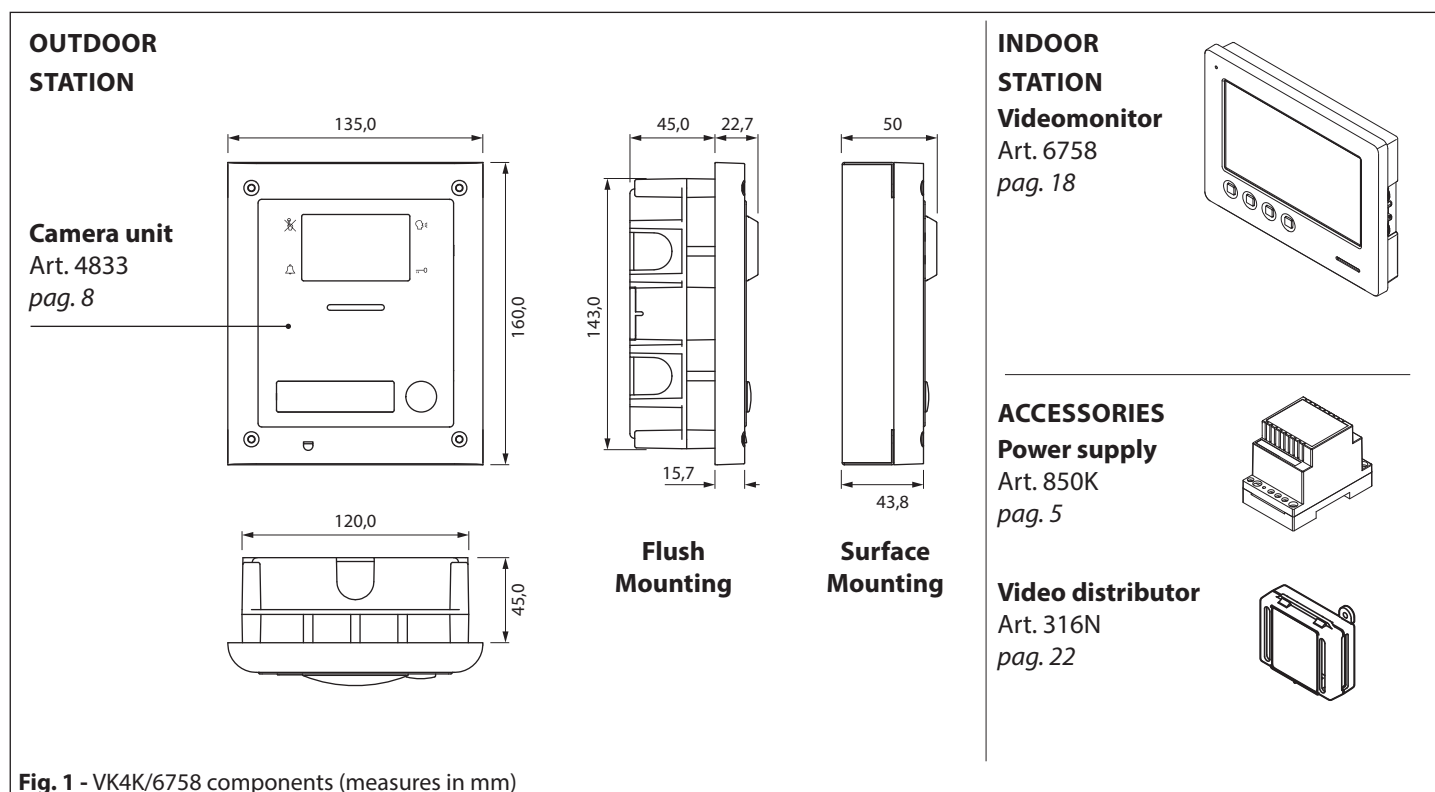

Fig. 1 - VK4K/6758 components (measures in mm)

VK4K-1/6758 - flush mounting			
ONE WAY VERSIONS	<p>1 Outdoor station composed of: 1 Art. 4833-1: 1 button camera unit 1 Art. 4851: Flush mounting box</p>	<p>1 Colour videomonitor Art. 6758</p>	<p>1 Power supply Art. 850K</p>
	<p>1 Outdoor station composed of: 1 Art. 4833-1: 1 button camera unit 1 Art. 4881: Surface mounting box</p>	<p>1 Colour videomonitor Art. 6758</p>	<p>1 Power supply Art. 850K</p>
VK4K-2/6758 - flush mounting			
TWO WAY VERSIONS	<p>1 Outdoor station composed of: 1 Art. 4833-2: 2 button camera unit 1 Art. 4851: Flush mounting box</p>	<p>2 Colour videomonitors Art. 6758</p>	<p>2 Power supplies Art. 850K</p>
			<p>1 Video distributor Art. 316N</p>
VK4K-2S/6758 - surface mounting			
TWO WAY VERSIONS	<p>1 Outdoor station composed of: 1 Art. 4833-2: 2 button camera unit 1 Art. 4881: Surface mounting box</p>	<p>2 Colour videomonitors Art. 6758</p>	<p>2 Power supplies Art. 850K</p>
			<p>1 Video distributor Art. 316N</p>

VK4KX/6758 Colour videokit with embended proximity key reader.

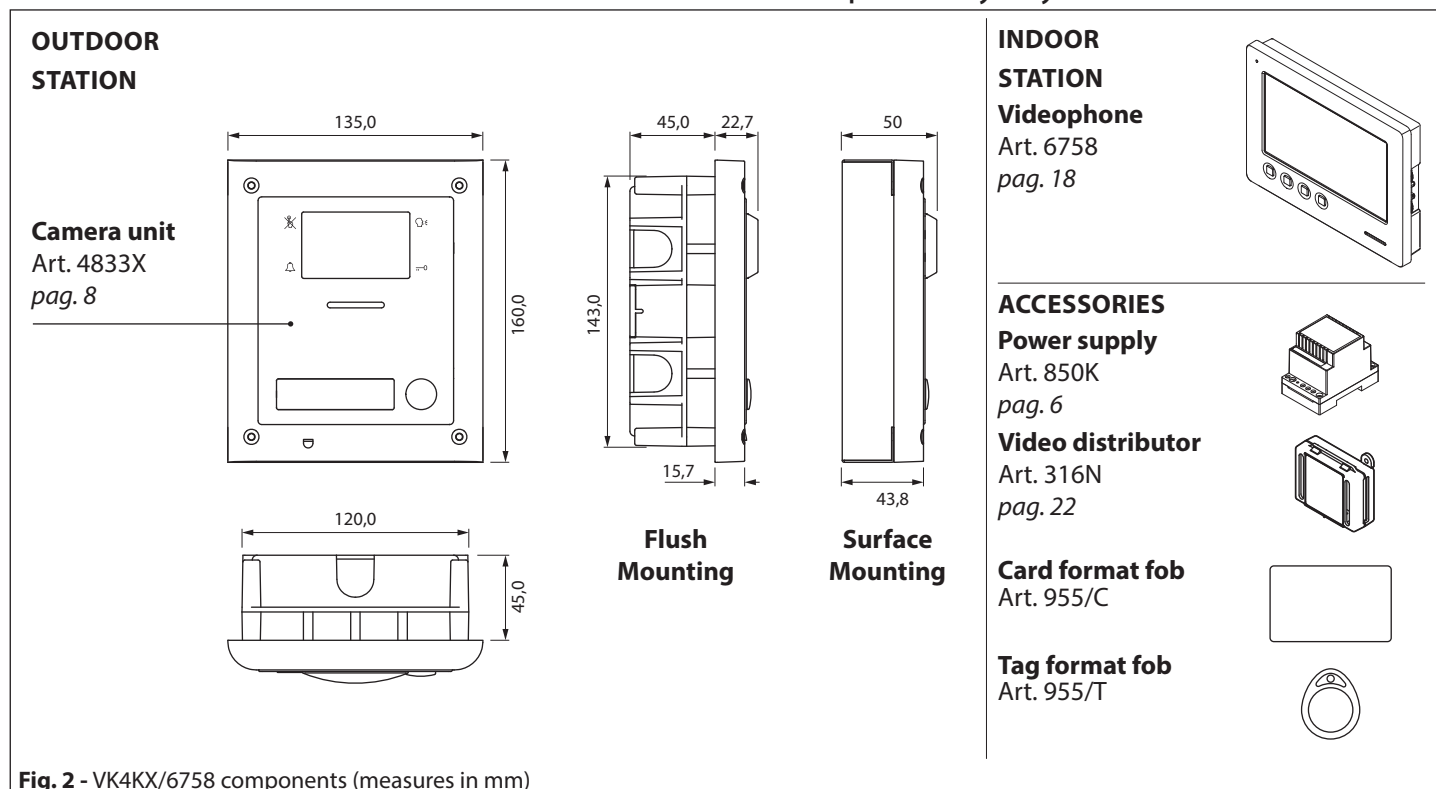











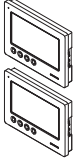
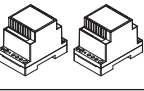



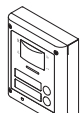
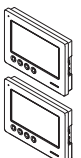
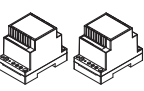





Fig. 2 - VK4KX/6758 components (measures in mm)

ONE WAY VERSIONS		TWO WAY VERSIONS		
VK4KX-1/6758 - flush mounting 	1 Outdoor station composed of: 1 Art. 4833X-1: 1 button camera unit 1 Art. 4851: Flush mounting box	 1 Colour videophone Art. 6758	 1 Power supply Art. 850K	 1 Card format fob Art. 955/C
			 2 Tag format fobs Art. 955/T	
VK4KX-1S/6758 - surface mounting 	1 Outdoor station composed of: 1 Art. 4833X-1: 1 button camera unit 1 Art. 4881: Surface mounting box	 1 Colour videophone Art. 6758	 1 Power supply Art. 850K	 1 Card format fob Art. 955/C
			 2 Tag format fobs Art. 955/T	
VK4KX-2/6758 - flush mounting 	1 Outdoor station composed of: 1 Art. 4833X-2: 2 button camera unit 1 Art. 4851: Flush mounting box	 2 Colour videophones Art. 6758	 2 Power supplies Art. 850K	 1 Card format fob Art. 955/C
			 1 Video distributor Art. 316N	 4 Tag format fobs Art. 955/T
VK4KX-2S/6758 - surface mounting 	1 Outdoor station composed of: 1 Art. 4833X-2: 2 button camera unit 1 Art. 4881: Surface mounting box	 2 Colour videophones Art. 6758	 2 Power supplies Art. 850K	 1 Card format fob Art. 955/C
			 1 Video distributor Art. 316N	 4 Tag format fobs Art. 955/T

VK4KC/6758 Colour videokit plus a codelock module.

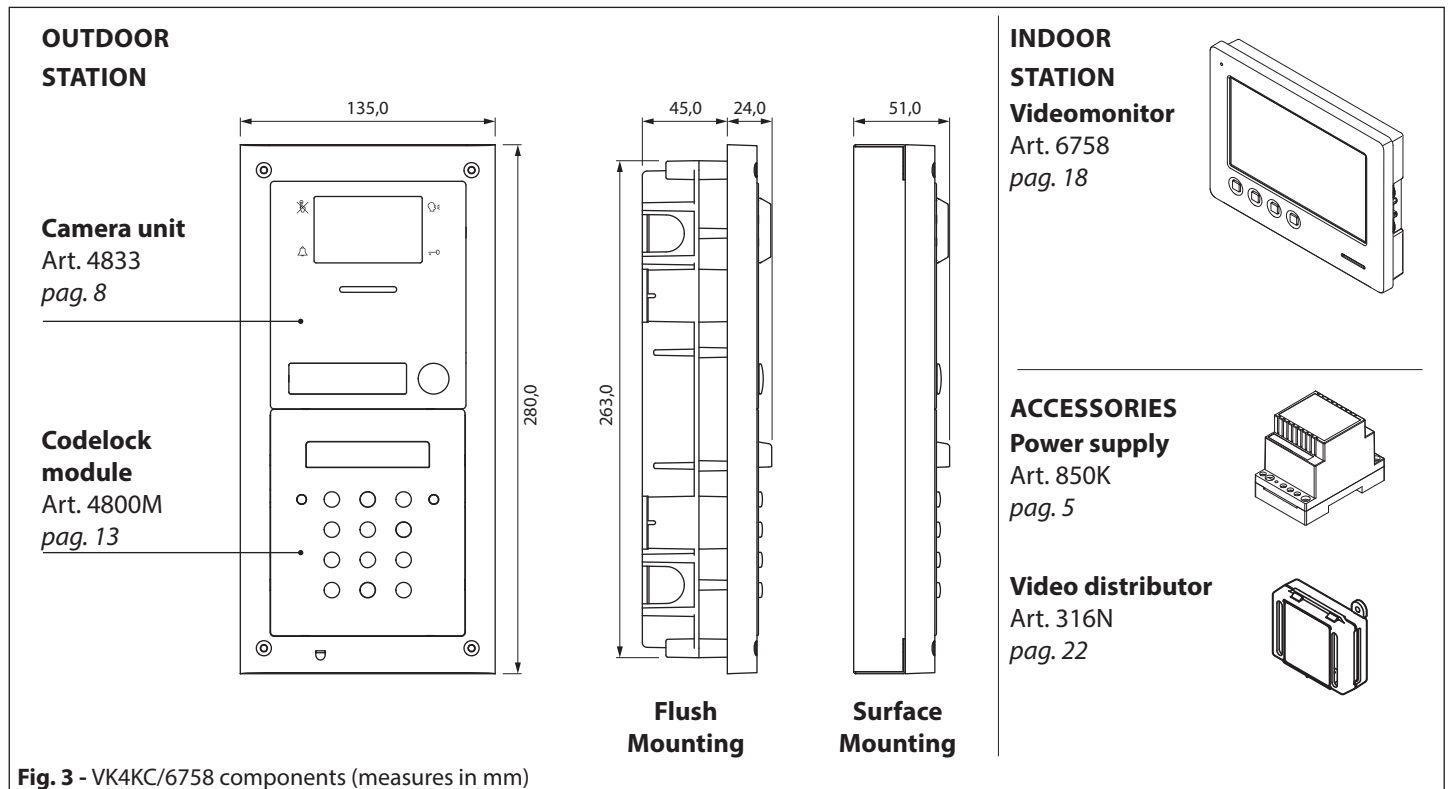
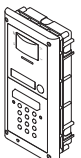

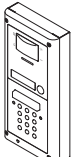

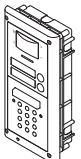
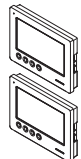
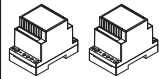
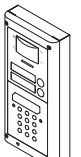
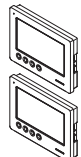
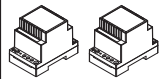



Fig. 3 - VK4KC/6758 components (measures in mm)

ONE WAY VERSIONS	VK4KC-1/6758 - flush mounting	 <p>1 Outdoor station composed of: 1 Art. 4833-1: 1 button camera unit 1 Art. 4800M: Codelock module 1 Art. 4852: Flush mounting box</p>	 <p>1 Colour videomonitor Art. 6758</p>	 <p>1 Power supply Art. 850K</p>
	VK4KC-1S/6758 - surface mounting	 <p>1 Outdoor station composed of: 1 Art. 4833-1: 1 button camera unit 1 Art. 4800M: Codelock module 1 Art. 4882: Surface mounting box</p>	 <p>1 Colour videomonitor Art. 6758</p>	 <p>1 Power supply Art. 850K</p>
TWO WAY VERSIONS	VK4KC-2/6758 - flush mounting	 <p>1 Outdoor station composed of: 1 Art. 4833-2: 2 button camera unit 1 Art. 4800M: Codelock module 1 Art. 4852: Flush mounting box</p>	 <p>2 Colour videomonitors Art. 6758</p>	 <p>2 Power supplies Art. 850K</p>
	VK4KC-2S/6758 - surface mounting	 <p>1 Outdoor station composed of: 1 Art. 4833-2: 2 button camera unit 1 Art. 4800M: Codelock module 1 Art. 4882: Surface mounting box</p>	 <p>2 Colour videomonitors Art. 6758</p>	 <p>2 Power supplies Art. 850K</p>
				 <p>1 Video distributor Art. 316N</p>
				 <p>1 Video distributor Art. 316N</p>

General directions for installation

CONNECTION TO MAINS

The system must be installed according to national rules in force, in particular we recommend to:

- Connect the system to the mains through an **all-pole circuit breaker** which shall have contact separation of at least 3mm in each pole and shall disconnect all poles simultaneously;
- The **all-pole circuit breaker** shall be placed for easy access and the switch shall remain readily operable.

POWER SUPPLY INSTALLATION

- Remove the terminal side covers by unscrewing the retaining screws;
- Fix the power supply to a DIN bar or directly to the wall using two expansion type screws;
- Switch off the mains using the circuit breaker mentioned above and then make the connections as shown on the installation diagrams;
- Check the connections and secure the wires into the terminals;
- Replace the terminal covers and fix them using the relevant screws;
- After completing the wiring, double check all connections then restore the mains.

CABLE SIZE

Video connections and Audio connections must be wired in twisted pair: pair the video lines (terminals/signals V1 and V2), pair the audio lines (terminals /signals 1 and 2).

⚠ IMPORTANT NOTE: SOLID COPPER CABLES MUST BE USED. COPPER COATED STEEL (CCS) AND COPPER COATED ALUMINIUM (CCA) CAN NOT BE USED ON THE SYSTEM.

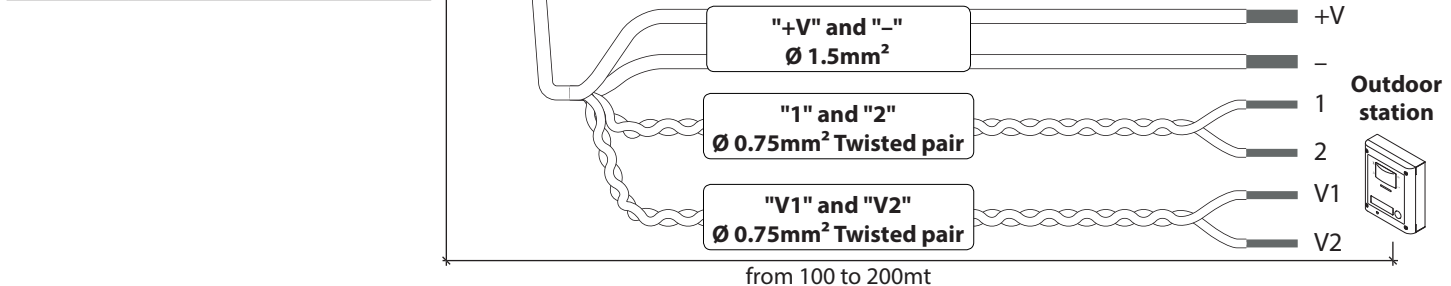
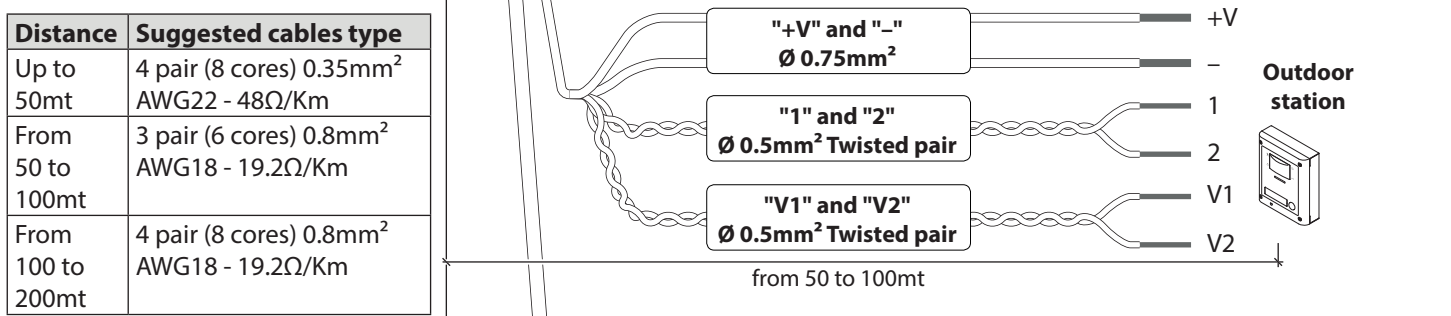
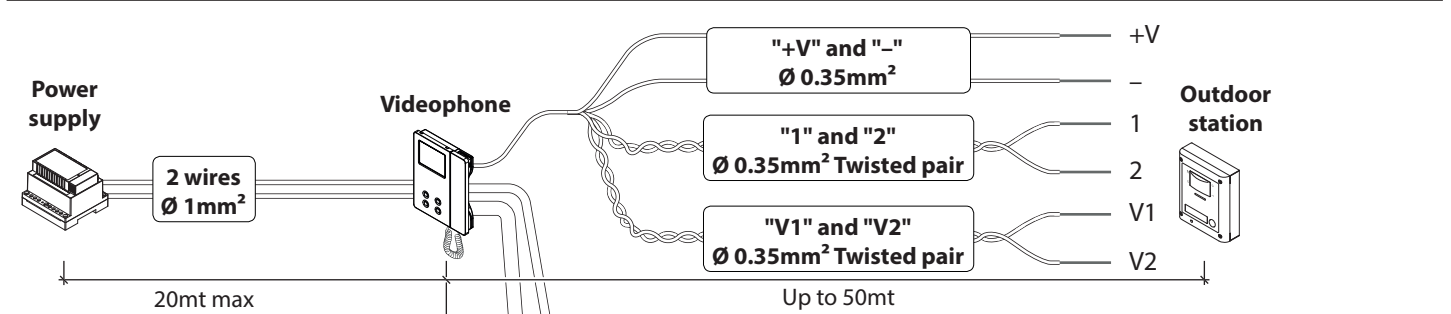
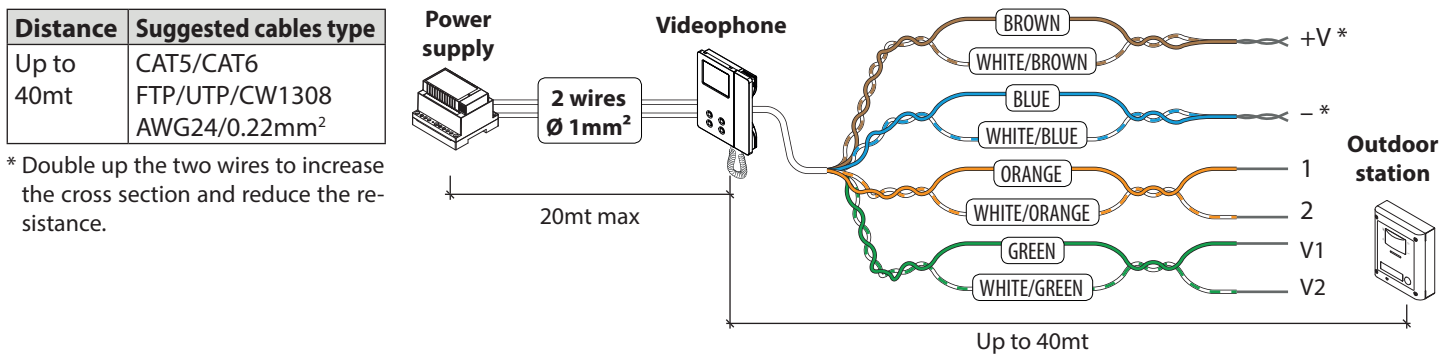

Troubleshooting guide

In case of system failure, try the following preliminary checks:

- Check that the cables are connected as shown in the installation diagram and that the cables are firmly fixed into the relevant terminals;
- Check that the mains voltage is available on terminals 230Vac (or 127Vac) and 0 of the power transformer Art. 850K;
- Check the 24Vac voltage output of the power transformer Art. 850K. If this voltage is not available it could be the 1,6A fuse, in this case remove the mains voltage, remove possible short-circuits or overload sources then replace the fuse with an equal or equivalent one.
- Check that the voltage between the terminals + and – of the speaker unit is between 16 and 20Vdc.

If the problem persists try the tests in the following table or contact technical support.

SYMPTOM	CAUSE	SOLUTION
The door station is not able to call the extension (the bell LED is switched on for 2 seconds):	<ul style="list-style-type: none"> • Wrong connection between door station and the videophone • Cable size too small. • Programmed videophone address incorrect. • You have changed the videophone address without powering down the system. 	<ul style="list-style-type: none"> • Check the 6 common wire connections especially wire 1 (speech line/data). • Increase cable size or double up using two wires for each connection. • Check videophone address on dip-switches. • Power down the system then power up again to detect the new videophone address.
External call works but when answered the communication fails:	<ul style="list-style-type: none"> • Cable size too small. 	<ul style="list-style-type: none"> • Increase cable size or double up using two wires for each signal.
During the conversation it is not possible to open the door:	<ul style="list-style-type: none"> • Cable size too small. 	<ul style="list-style-type: none"> • Increase cable size or double up using two wires for each signal.
During the conversation it is not possible to open the door but the key LED on the door station switches on for the programmed time:	<ul style="list-style-type: none"> • Incorrect position of J2 jumper. • Electric lock wires unconnected or in short. • Wrong electric lock type. 	<ul style="list-style-type: none"> • Check J2 position on the door station. • Check connection. • Check that the electric lock type (ac or dc) is suitable for the J2 position chosen.
Speech only from outside to inside:	<ul style="list-style-type: none"> • Wire 2 broken or in short. 	<ul style="list-style-type: none"> • Check connection of wire 2.
Low volume of speech:	<ul style="list-style-type: none"> • Volume trimmers of door station require adjustment. 	<ul style="list-style-type: none"> • Adjust the trimmers until the required volume is reached.
Noise over the speech line during the conversation:	<ul style="list-style-type: none"> • The 6 common wires are cabled together with 230 or 380Vac power lines. • The 6 common wires are cabled together with 24Vac videophone power supply wires. 	<ul style="list-style-type: none"> • Separate the 6 common wires from the high voltages cables. • Separate the 6 common wires from the two 24Vac wires or cable them together only for a short distance.
Camera recall service does not work:	<ul style="list-style-type: none"> • Camera recall button pressed for a number of times different from the ID of the door station to be switched on. 	<ul style="list-style-type: none"> • Check the ID (1..4) of the door station to be recalled and press the camera recall button as many time as the ID value.
Intercommunicating call does not work:	<ul style="list-style-type: none"> • "Key" button pressed for a number of times different from the videophone address value. 	<ul style="list-style-type: none"> • Check the address of the videophone you are calling and try again.
The video shown on the monitor is of a bad quality and the image is distorted or double	<ul style="list-style-type: none"> • V1,V2 signals unconnected, reversed or shorted. • The switches of the two way dip-switch are not both in ON position. • V1,V2 of the last Art. 316N (if present) not closed with 75 Ohm resistor. 	<ul style="list-style-type: none"> • Check that the wires are not broken or shorted. • Set both switches to the ON position. • Use 2x 75 Ohm resistors to connect V1 & V2 to 0V.
Local call does not work:	<ul style="list-style-type: none"> • Wrong connection or call button broken. 	<ul style="list-style-type: none"> • Check connection or replace the button.

Art. 4833/4833X Speaker unit

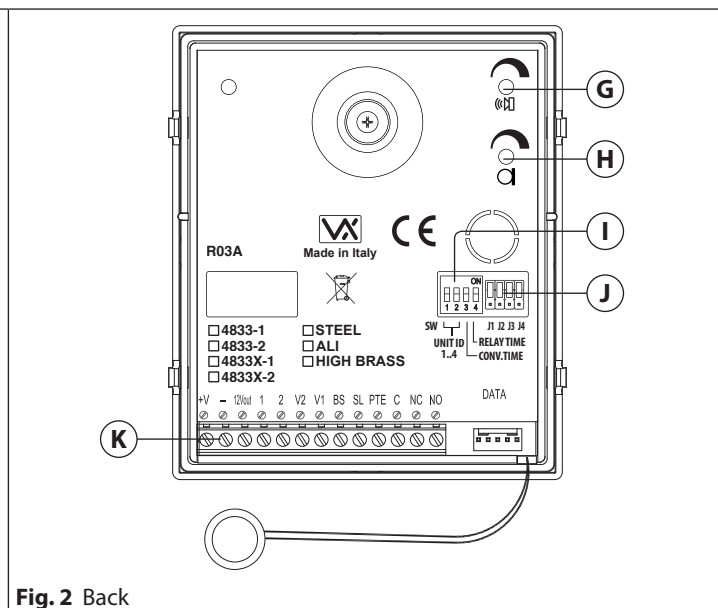
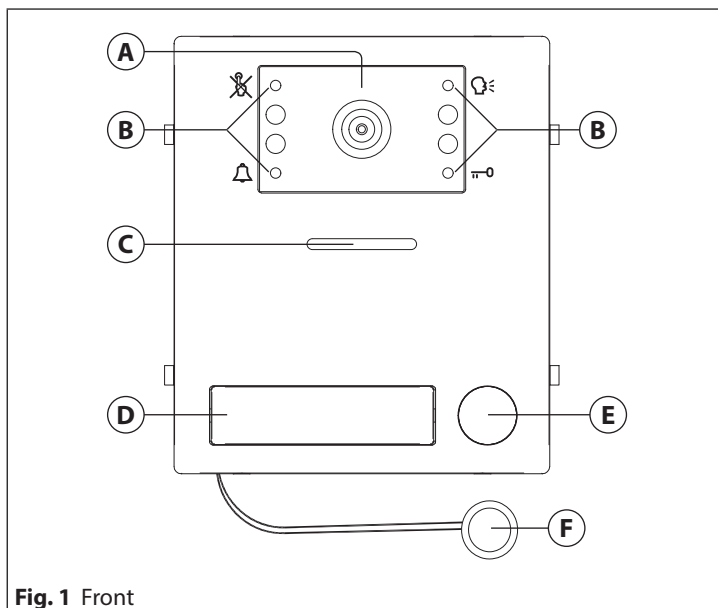

DESCRIPTION

Speaker unit module comprising of high quality auto iris CCD Day/Night colour camera with infrared illumination LEDs.

LEGEND

- Ⓐ Camera with illumination LEDs;
- Ⓑ Operation LEDs;
- Ⓒ Loudspeaker;
- Ⓓ Card name holder with built-in proximity reader;
- Ⓔ Call push button (1 or 2 depending on the model);
- Ⓕ Microphone;
- Ⓖ Balance Control;
- Ⓗ Loudspeaker volume control;
- Ⓘ 4 way Dip-switch;
- ⓵ Jumpers;
- Ⓚ Connection terminals.

AVAILABLE VERSIONS

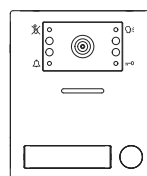



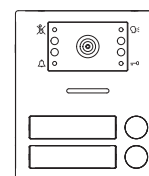

Art. 4833-1
Art. 4833X-1





Art. 4833-2
Art. 4833X-2

LEDS

	When illuminated, indicates that it is not possible to make a call because a call or a conversation is in progress (from the outdoor station from which you are calling or from another outdoor station on systems with multiple entrances). The LED will be off when the system is in stand-by.
	If illuminated, indicates that the call from the outdoor station is in progress. The LED will switch OFF when the call is answered or after the programmed number of rings.
	If illuminated, indicates that it is possible to speak because the call has been answered. The LED will switch OFF at the end of a conversation (or at the end of the conversation time).
	If illuminated, indicates that the door lock has been activated. It will switch OFF at the end of the programmed "door opening" time.

CONTROLS

	Trimmer to adjust the speaker volume. Rotate clockwise to increase or anticlockwise to decrease.
	Trimmer to adjust the microphone volume. Rotate clockwise to increase or anticlockwise to decrease.

SETTINGS (DIP-SWITCH & JUMPERS)

4 WAY DIP-SWITCH		
First two switches are used to set the speaker unit address: the speaker unit address is required for camera recall operation on 2 or more entrance systems.		
<p>SW</p>	Switches 1,2	Unit Address
	OFF OFF	1
	ON OFF	2
	OFF ON	3
ON ON	4	
<p>SW</p>	Switches 3	Conversation Time
	OFF	60 seconds
ON	120 seconds	
<p>SW</p>	Switch 4	Door opening time (J2 = "L" position)
	OFF	2 seconds
ON	6 seconds	

JUMPERS J1, J2, J3, J4	
<p>J1 J2 J3 J4</p>	J1 Position Call reassurance tone volume
	H High L Low
<p>J1 J2 J3 J4</p>	J2 Position Door open relay operating mode
	H Capacitor discharge L Dry contacts
<p>J1 J2 J3 J4</p>	J3 Position Call buttons operating mode (only for Art. 4833)
	H Both buttons call the same videophone (Address 1) L Each button calls a different videophone
<p>J1 J2 J3 J4</p>	J4 Position Built-in relay – back EMF protection (MOV)
	H NC contact L NO contact

BUILT-IN RELAY – BACK EMF PROTECTION

The Art. 4833 includes selectable back EMF protection on the relay. The jumpers marked J4 is used to select the protection type. When using a fail secure lock with connections C & NO the jumper should be in the NO position. When using a fail open lock with connections C & NC the jumper should be in the NC position and when used to trigger a gate controller or another third party controller the jumper should be removed completely (This disables the protection on the relay).

LOCK RELEASE BACK EMF PROTECTION

A varistor must be fitted across the terminals on AC lock release (**Fig.1A**) and a diode must be fitted across the terminals on a DC lock release (**Fig.1B**) to suppress back EMF voltages. Connect the components to the lock releases as shown in figures.

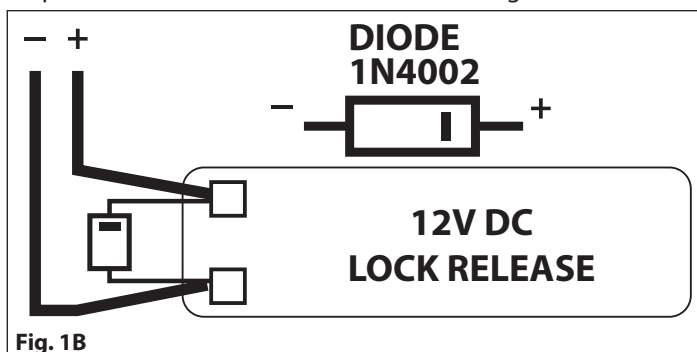
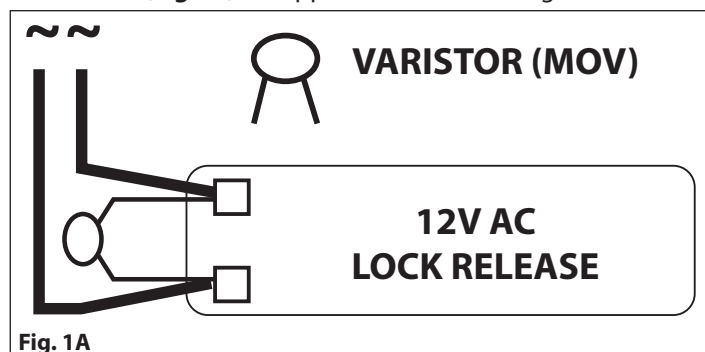

PROGRAMMING TAGS (ONLY FOR ART. 4833X)

MASTER CARD

The module is supplied with a master card. The master card is preprogrammed in the factory.

The card is used to add and delete user access tags.

If the master card is lost, a new one will need to be created using the procedure detailed further on in this manual. In this instance, it will be necessary to reprogram all the user tags. The module allows to store up to 30 user tags.

Note: when the master card is required, place it in front of the reader so that the middle of the card is in front of the middle of the card name holder.



PROGRAMMING USERS TAG

The user tags can be programmed on the module using the master card to access the programming mode:

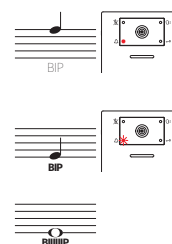
- Place the master card in front of the tag reader.
 ↳ The module emits one high-pitched "beep" sound and the LED illuminates
- Press the call button (the lower call button in the case of a 2-button external module) "n" times where n is a value between 1 and 30 and specifies the tag number.
 ↳ On each press the module emits a low-pitched "beep" sound and the LED flashes.



Note: the external module emits a low-pitched continuous "beeping" sound if an already programmed location is selected.

3. When the desired memory location is reached the  LED starts flashing waiting for a tag.
4. Place the user tag to be programmed in front of the tag reader.
 - ↳ The module emits a low-pitched "beep" sound, the tag is programmed. The  LED stops flashing and remains illuminated.

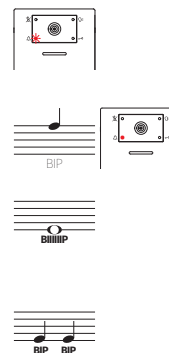

Note: the module emits a low-pitched continuous "beeping" sound if an already programmed location is selected.

5. Repeat steps 2 to 4 for to program further tags.
6. To exit programming mode:
 - » Place the master key in front of the tag reader, or
 - » Wait 10 seconds.
 - ↳ The module emits two low-pitched "beep" sounds indicating it is back in normal operating mode.



USING TAGS



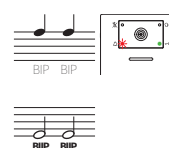

Place a tag in front of the tag reader:

- ↳ If the tag is programmed, the external module emits two high-pitched "beep" sounds and activates the relay. The  LED flashes twice and the  LED illuminates for the door opening time.
- ↳ If the tag is not programmed, the external module emits two low-pitched "beeping" sounds.



DELETING A SINGLE USER TAG

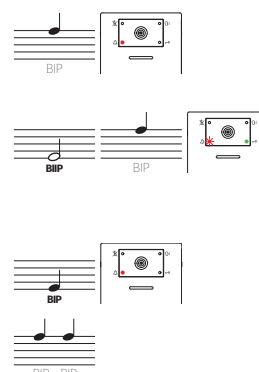

The master card is required to delete a user.

1. Place the master key in front of the tag reader.
 - ↳ The module emits one high-pitched "beep" sound and the  LED illuminates.
2. Press and hold the call button (the lower call button in the case of an external 2-button module).
 - ↳ The module emits a low-pitched "beeping" sound then after 1-2 seconds emits a high-pitched "beep" sound and the  LED starts flashing, release the call button.
3. Press the call button (the lower call button in the case of a 2-button external module) "n" times where n is a value between 1 and 30 and specifies the memory location to delete.
 - ↳ On each press the module emits a low-pitched "beep" sound and the  LED stops flashing.
4. When the  LED restarts flashing, place the master card in front of the tag reader.
 - ↳ The module emits two high-pitched "beep" sounds then the module exits programming mode.



DELETING ALL USER TAGS

The master card is required to delete all user tags together.

1. Place the master card in front of the tag reader.
 - ↳ The module emits one high-pitched "beep" sound and the  LED illuminates.
2. Press and hold the call button (the lower call button in the case of an external 2-button module).
 - ↳ The module emits a low-pitched "beeping" sound then after 1-2 seconds emits a high-pitched "beep" sound and the  LED starts flashing, release the call button.
3. Press and hold the call button (the lower call button in the case of a 2-button module).
 - ↳ The module emits a low-pitched "beep" sound and the  LED stops flashing.
4. Place the master card in front of the tag reader while keeping the button pressed.
 - ↳ The module emits two low-pitched "beep" sounds then the module exits programming mode.

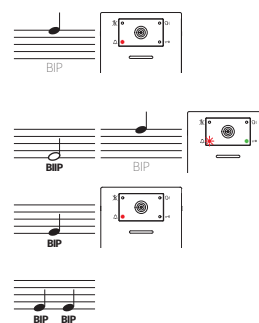



IDENTIFYING A TAG

The master card is required to identify a programmed tag.

1. Place the master card in front of the tag reader.
 - ↳ The module emits one high-pitched "beep" sound and the  LED illuminates.



2. Place the tag to identify in front of the tag reader.
 - ↳ The module emits one high-pitched "beep" sound then the  LED flashes for a number of times that corresponds to the key number then the module emits another high-pitched "beep" sound and the  LED remains fixed on.
3. Repeat step 2 to identify other tags.
4. To exit programming mode:
 - » Place the master key in front of the tag reader, or
 - » Wait 10 seconds.
 - ↳ The module emits two low-pitched "beep" sounds to indicate it is back in normal operating mode.

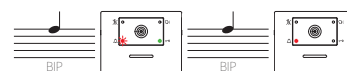

REPROGRAMMING A MASTER CARD

⚠ The following procedure will delete all user tags.

If the master card is lost or damaged, a new one can be programmed using the following procedure:

1. Switch off the power.
2. Open the external module frame.
3. Bridge the **PTE** and **GND** terminals or press and hold down the "push to exit" button, if this is wired to the external module (refer to the module's instructions).
4. Switch the power back on.
 - ↳ The module emits a high-pitched "beep" sound.
5. Remove the short between the **PTE** and **GND** terminals or release the "press to exit" button.
 - ↳ The module emits a high-pitched "beep" sound and the  LED starts flashing.
6. Place the master tag in front of the tag reader.
 - ↳ The module emits two high-pitched "beep" sounds, then two low-pitched "beep" sounds, the master tag is programmed, all user tags have been deleted and the module exits programming mode.

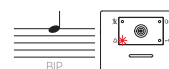
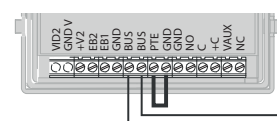

HOW TO CONNECT ELECTRIC LOCK

The "door-open" relay can operate either as "dry contact" or "capacitive discharge" mode.

- In "dry contact" operation mode the relay works in a traditional way, a power supply or a power source is needed to operate the lock (12-24Vac/dc 2A max), and activation lasts according to the door opening time programmed.
- In "capacitive discharge" operation mode the relay's contacts, when active, supply directly the lock (12Vac/dc 1A max) for a moment. You don't need a power supply for the lock and the door opening time programmed does not affect the activation time.

A possible deterioration of the mechanical performance of the electric lock, might cause the "capacitive discharge" to malfunction in time. In case the electric lock is used in very dusty environments or in peculiar climate conditions, we suggest to use the lock in dry contact mode.

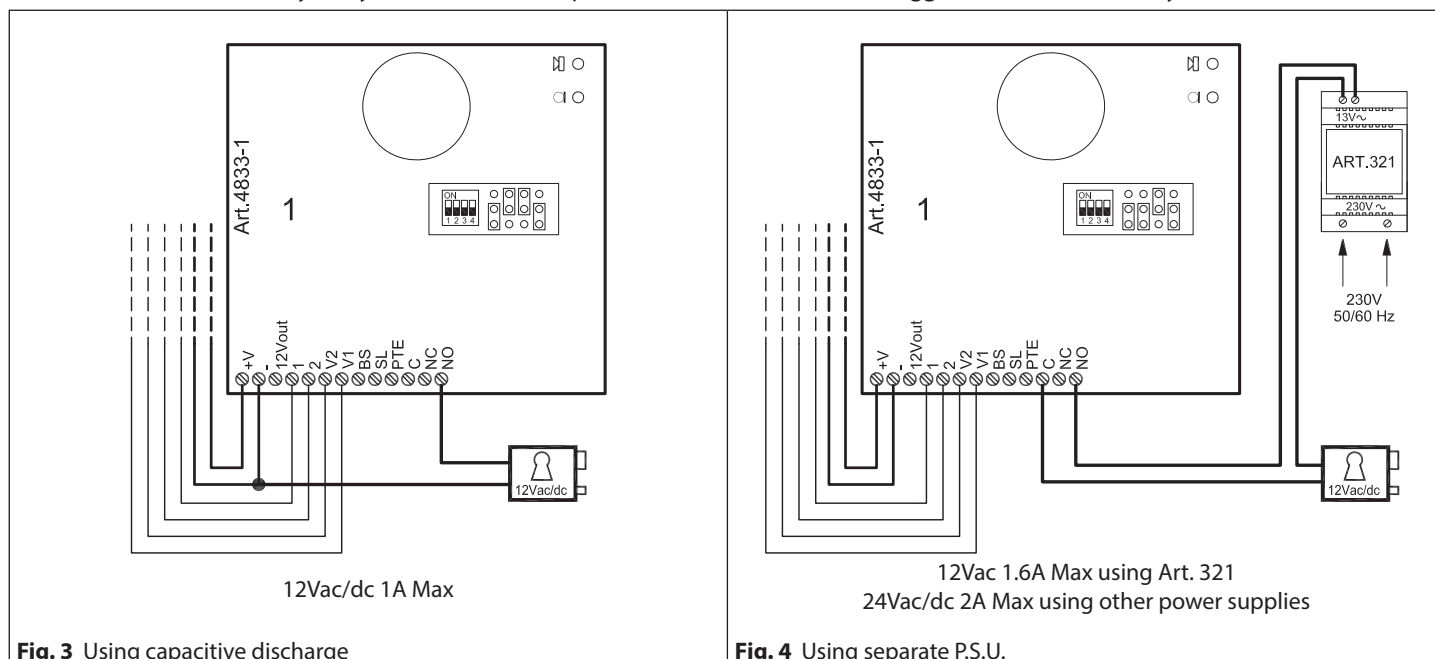

Fig. 3 Using capacitive discharge

Fig. 4 Using separate P.S.U.

CONNECTION TERMINALS SIGNALS

+V	Power input 16÷20Vdc	
-	Power input ground	
12Vout	12Vdc. 0,3A max. output to supply accessories	
1	Speech line input toward the loudspeaker and data signal (approx. 12V in stand-by, approx. 5V with a conversation in progress)	
2	Speech line output from the microphone (approx. 12V in stand-by, approx. 3V with a conversation in progress)	
V1	Balanced video signal sync.-	
V2	Balanced video signal sync.+	
BS	Input/Output busy signal (approx. 12V in stand-by, approx. 0V with a call in progress)	
SL	Active low output to enable the enslavement relay for video signal exchange (active with a call in progress)	
PTE	Active low input to control directly the door open relay	
C	Door open relay common contact	Max 24Vdc, 3A when used as dry contacts relay
NC	Door open relay normally closed contact	
NO	Door open relay normally open contact	

ADHESIVE GASKET PLACEMENT

Apply the (Y) seal as shown in **Fig. 5**.

ANTI-TAMPERING LOCKS FIXING

Fit the anti-tampering locks (W) as shown in **Fig. 6**.

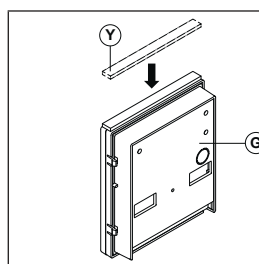

Fig. 5

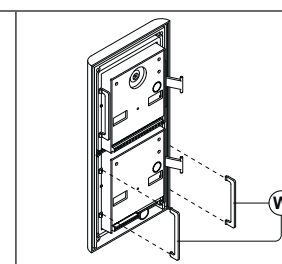

Fig. 6

HOW TO REMOVE/INSERT THE CARD NAME HOLDER

- To avoid damage to the module front plate, mask the side that will be in contact with the screwdriver blade;
- Insert the screwdriver (flat side) into the card-holder hole as shown in **Fig. 7**;
- Move the screwdriver to the left as shown in **Fig. 8** to extract the card name holder;
- Edit the card name then replace it inside the holder and refit: insert the holder inside its housing from the left or right side then push the other side until it clips into place.

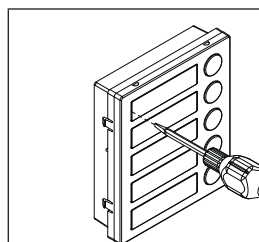

Fig. 7

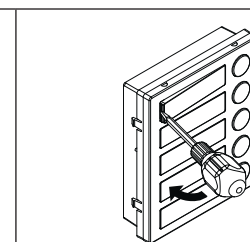
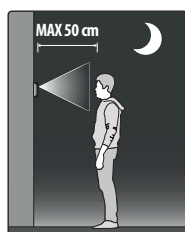

Fig. 8

MAXIMUM ILLUMINATION DISTANCE FROM CAMERA AT NIGHT

The illumination LED's within the camera will illuminate the visitor when they are within 50 cm of the camera.



Note: The camera supplied may be either a CCD (With IR illumination) or CMOS (With white LED illumination) sensor. This difference does not affect the performance.

CLEANING OF THE PLATE

Use a clean and soft cloth. Use moderate warm water or non-aggressive cleansers.

Do not use:

- abrasive liquids;
- chlorine-based liquids;
- metal cleaning products.

TECHNICAL SPECIFICATION

Power Supply: Supplied by the BUS line, 20Vdc
Power consumption: Stand-by: 70mA
 Operating: 250mA
Working Temperature: -10 +50° C

Art. 4800M Digital codelock module

CODELOCK UNIT MODULES ART. 4800M

The module features 12 stainless steel buttons (Keys **0 - 9**, **ENTER** and **CLEAR**), 2 LED's for progress information during use and programming and a mirror finish stainless steel front plate (Standard version). With three integral relays each with common, normally open and normally closed connections and two inputs to enable the external triggering of relays one and two (For example, push to exit button). Key presses are signalled both acoustically and visually while each button press has a tactile feel. Entering the correct code followed by ENTER will activate the relevant relay. Programming is carried out through the same keypad following a simple programming menu. The module can be combined with other 4000 Series modules in an audio or video intercom system.

MAIN FEATURES

- 3 C, NC, NO relay outputs (24Vac/dc – 5A max);
- 3 Programmable secret codes (one for each relay);
- Each relay can be set to be activated for a specific time (01 to 99 seconds) or to work as latch;
- Two active low inputs to command directly the relay 1 and 2;
- Programming menu guarded by a 4-8 digit programmable engineer's code;
- Visual and Acoustic signal during operating and programming;
- Keypad illumination LEDs;

GENERAL DIRECTIONS FOR INSTALLATION

In order to achieve the best results from the schematics described it is necessary to install only original VIDEX equipment, strictly keeping to the items indicated on each schematic and follow these General Directions for Installation:

- The system must be installed according to national rules in force, in any case the running of cables of any intercom unit must be carried out separately from the mains;
- All multipair cables should be compliant to CW1308 specification (0.5mm twisted pair telephone cable).
- Cables for speech line and service should have a max resistance of 10 Ohm
- Lock release wires should be doubled up (Lock release wires and power supply wires should have a max resistance of 3 Ohm);
- The cable sizes above can be used for distances up to 50m. On distances above 50m the cable sizes should be increased to keep the overall resistance of the cable below the RESISTANCES indicated above;
- Double check the connections before power up;
- Power up the system then check all functions.

LOCK RELEASE BACK EMF PROTECTION

A varistor must be fitted across the terminals on AC lock release (**Fig.1A**) and a diode must be fitted across the terminals on a DC lock release (**Fig.1B**) to suppress back EMF voltages. Connect the components to the lock releases as shown in figures.

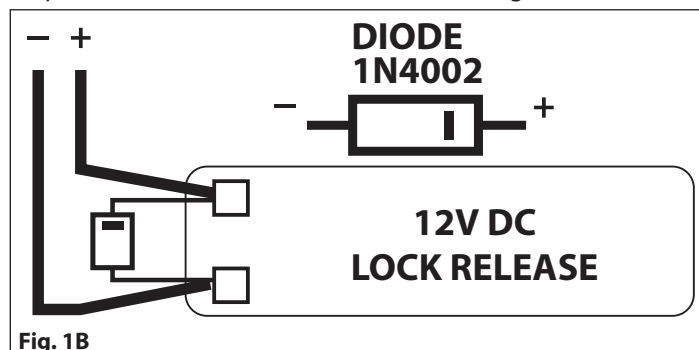
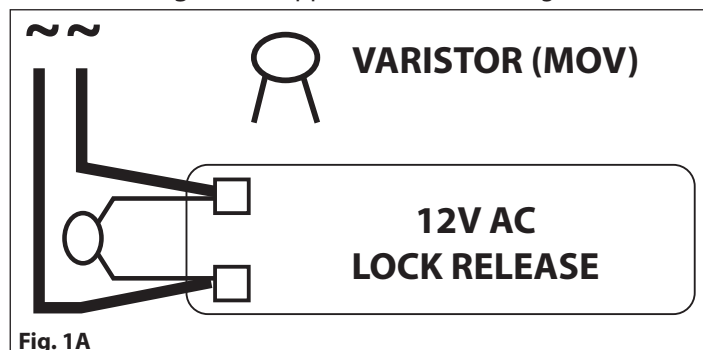

Fig. 1 - Art. 4800M

Art. 4800M Digital codelock module**BUZZER BACK EMF**

When using intercoms with buzzer call (Art.924/926, SMART1/2, 3101/2, 3001/2 and 3021/2) add one 0.1uF (100nF) capacitor between terminals 3 and 6 on the telephone.

BUILT-IN RELAYS – BACK EMF PROTECTION

The Art. 4800M includes selectable back EMF protection on the relays. The jumpers marked MOV (One jumper for each relay) are used to select the protection type. When using a fail secure lock with connections C & NO the jumper should be in the NO position. When using a fail open lock with connections C & NC the jumper should be in the NC position and when using the codelock to trigger a gate controller or another third party controller the jumper should be removed completely (This disables the protection on the relay).

PROGRAMMING (SEE ALSO THE RELEVANT FLOW CHART)

- Enter the "ENGINEER'S CODE": first time type six times "1" (111111 factory preset) and press "ENTER" (The red LED will illuminate);
- Confirm "ENGINEER'S CODE" (typing again the same) or type the new code (4 to 8 digits) then press "ENTER" (Melody). Pressing twice the "ENTER" button without changing the "ENGINEER'S CODE", will exit from the programming;
- Enter the code (4 to 8 digits) to enable "RELAY 1" or re-enter the existing code then press "ENTER" (Melody);
- Enter the "RELAY 1" operation time (2 digits 01 to 99 I.E. 05=5 seconds, 00= remain open time) or re-enter the existing time then press "ENTER" (Melody);
- Enter the code (4 to 8 digits) to enable "RELAY 2" or re-enter the existing code then press "ENTER" (Melody);
- Enter the "RELAY 2" operation time (2 digits 01 to 99 I.E. 05=5 seconds, 00= remain open time) or re-enter the existing time then press "ENTER" (Melody);
- Enter the code (4 to 8 digits) to enable "RELAY 3" or re-enter the existing code then press "ENTER" (Melody);
- Enter the "RELAY 3" operation time (2 digits 01 to 99 I.E. 05=5 seconds, 00= remain open time) or re-enter the existing time then press "ENTER" (Melody);
- The system is ready to use (the red LED will be off).

PROGRAMMING NOTES

- After pressing enter following a command, press "ENTER" a further twice to exit the programming menu.

RETURN SYSTEM TO PRESET ENGINEER'S FACTORY CODE

- Turn off power to code lock;
- Keep "ENTER" button pressed while turning the power back on;
- Release "ENTER" button;
- The engineer's code is now set to "111111" (six times one).

OPERATION

- Type in the programmed code and press "ENTER";
- If the code is correct, the green LED will illuminate for approx. 2 seconds and the relay relevant to the code will operate for the programmed time;
- If a wrong code is entered, a continuous melody will sound for 4 or more seconds, according to the number of mistakes;
- To switch off any relay while operating, type in the relevant code then press the "CLEAR" button;

OPERATION NOTES

- To operate relays together, set the same code for each relay;
- If a wrong code is entered, the system will lock out for 5 seconds which will increase each time a wrong code is entered. The system will operate only when the correct code is entered.

TERMINALS:

SW2	Relay 2 command signal (active low)	Max 24Vac/dc 3A
SW1	Relay 1 command signal (active low)	
NC3	Relay 3 normally closed contact	
NO3	Relay 3 normally open contact	
C3	Relay 3 common contact	
NC2	Relay 2 normally closed contact	
NO2	Relay 2 normally open contact	
C2	Relay 2 common contact	
NC1	Relay 1 normally closed contact	
NO1	Relay 1 normally open contact	
C1	Relay 1 common contact	
-	12/24Vac/dc power input	
+		

TECHNICAL SPECIFICATION

Power Supply:	12/24 Vac/dc – 2VA
Power Consumption:	Stand-by: 20mA
	Operating: 70mA
Working Temperature:	-10 +50° C

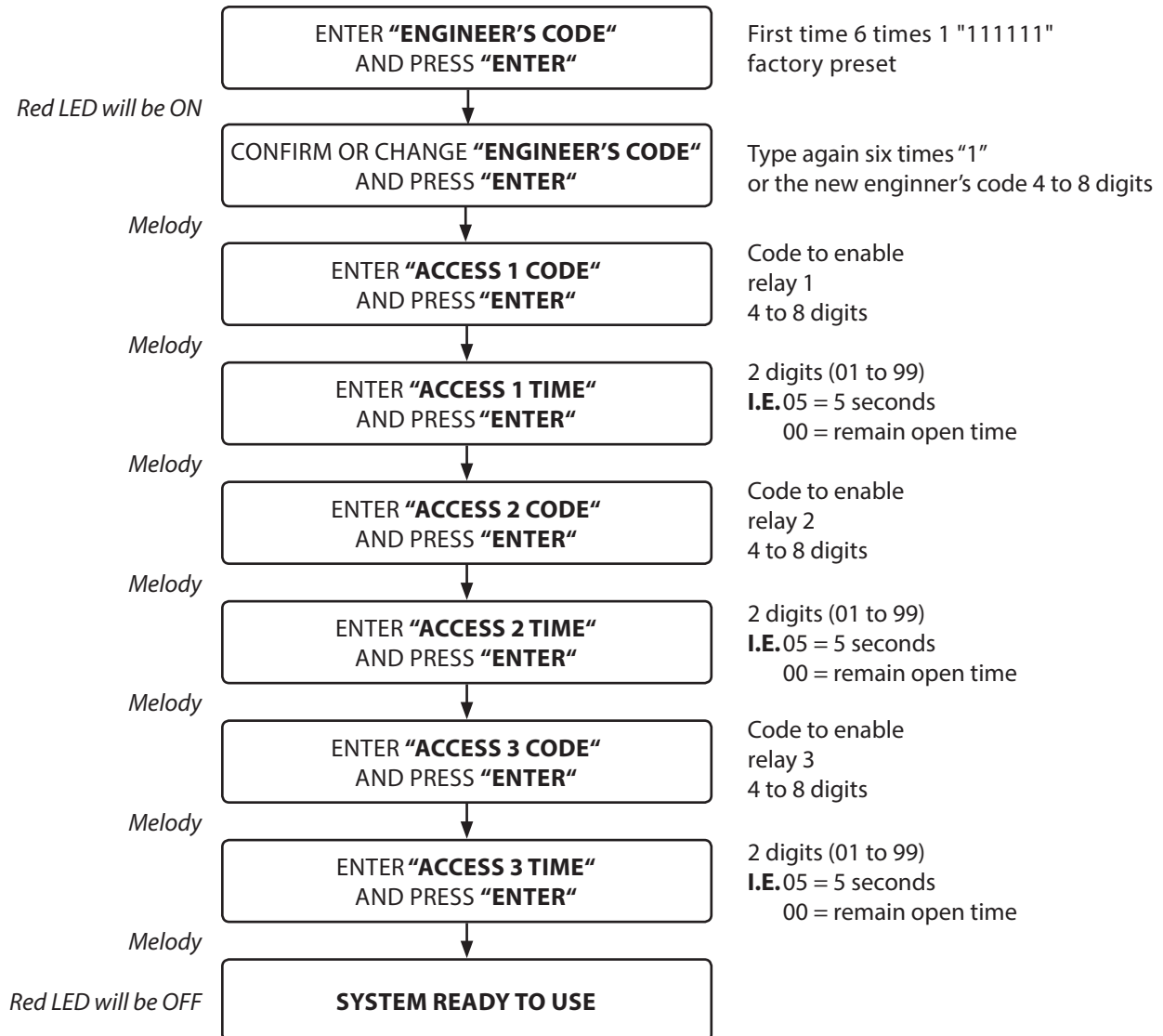
PROGRAMMING FLOW-CHART

4000 Series Surface and flush mounting door station installation

EXAMPLE: INSTALLING A FOUR MODULE OUTDOOR STATION

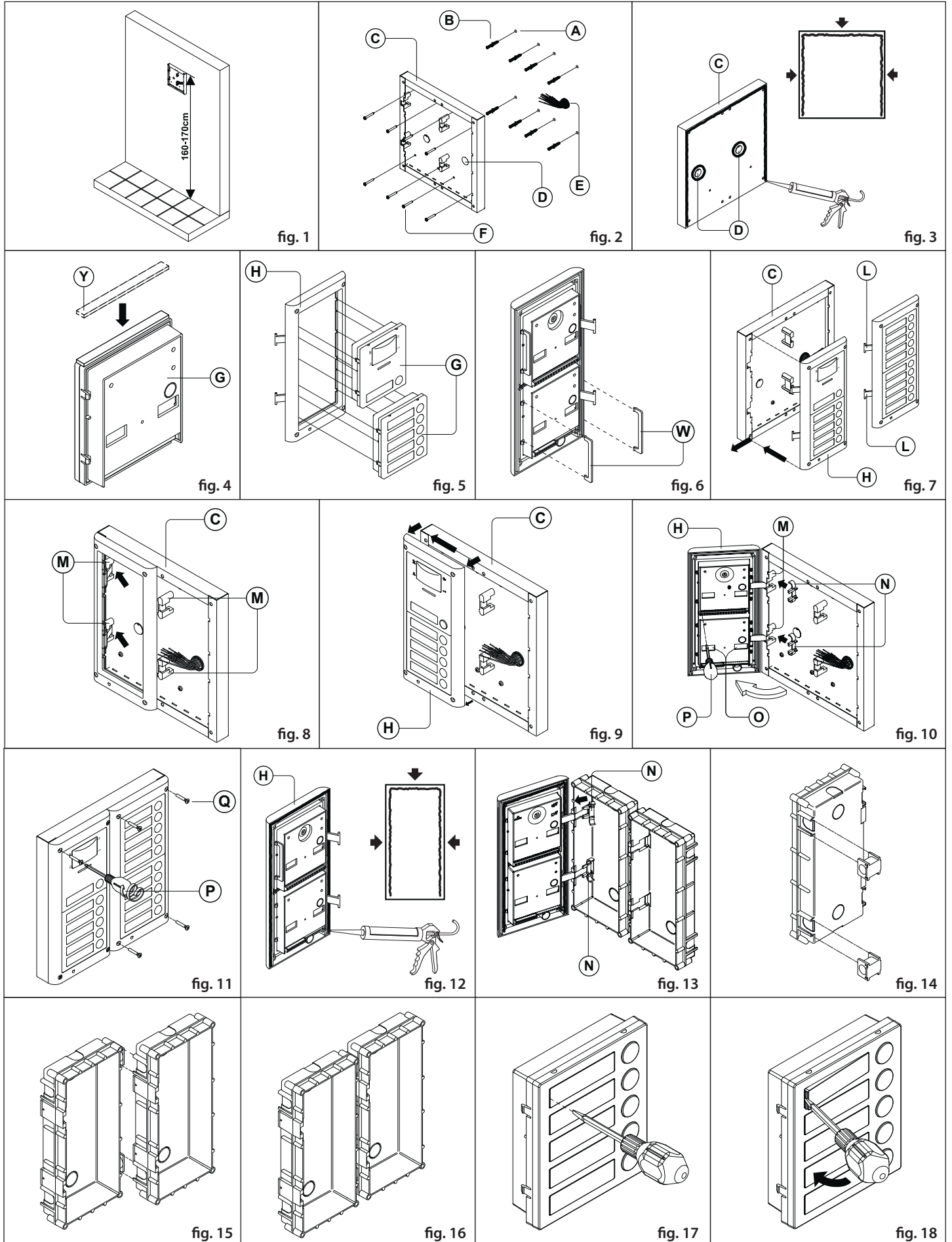

4000 Series Surface and flush mounting door station installation

INSTALLING A SURFACE MOUNT DOOR STATION

- Place the surface box against the wall (165-170cm between the top of the box and the floor level as shown in **Fig. 1**) and mark the fixing holes for the wall plugs and the hole for the cables **(E)** (**fig. 2**). Observe the orientation of the box with the hinge on the left;

⚠ In order to prevent water ingress we highly recommend using a silicon sealant between the wall and the back box **(C) ON THE LEFT, TOP AND RIGHT SIDES ONLY AND AROUND ALL HOLES **(D)**. DON'T USE SILICON SEALANT ON THE BOTTOM SIDE OF THE BACK BOX (Fig.3);**

- As shown on **Fig. 2**, drill the fixing holes **(A)**, insert the wall plugs **(B)** and feed the cables **(E)** through the surface box opening **(D)**, fix surface box **(C)** to the wall using the screws **(F)**;
- Apply the **(Y)** silicon sealant on top of each module as shown in **Fig. 4**;
- Before installation of the module support frame, hook the modules **(G)** to the support frame **(H)** as shown in **Fig. 5** then, as shown in **Fig. 6**, fit the two anti-tampering locks **(W)** for each module (do the same for the second module support frame);
- When you have more than one support frame, hook the support frame to the surface box starting from the left. For convenience we will described how to attach the left frame but the same must be carried out for the right frame. As shown in **Fig. 7**, hook the module support frame **(H)** (complete with modules) to the surface box **(C)** moving the frame as suggested from pointers. Ensure that the pivots **(L)** (**Fig. 7**) go inside the relevant housing **(M)** as shown in **Fig. 8**;
- As shown on **Fig. 9**, pull back the module support frame **(H)** while moving it slightly to the left as suggested by the pointers;
- As shown in **Fig. 10**, open the module support frame **(H)** as suggested by the pointer, hook the hinge locks **(N)** to the hinges **(M)**, make the required connections using the screwdriver provided **(P)** (flat blade end) and make the required adjustment by adjusting the settings (through openings **(O)**) and adjust trimmers;
- Repeat the same operations described above for the second module support frame (or for the third if available);
- When the system has been tested and is working correctly, move back the module support frames carefully, fix them to the surface box using the screwdriver provided **(P)** (torx end) and the pin machine torx screws **(Q)** (**Fig. 11**). **Note: do not over tighten the screws more than is necessary.**

INSTALLING A FLUSH MOUNTING DOOR STATION

When flush mounting and the number of modules is greater than 3, the required back boxes need to be linked together (before embedding them in the wall) as shown on **Fig. 14, 15 and 16**:

- Arrange the back boxes and remove knockouts to allow cables to be fed from one back box to the other;
 - Hook the spacers to first back box then hook the second back box to obtain the result shown on **Fig. 16**;
- Protect the module support frame fixing holes from dust then embed the back box into the wall (165-170cm between the top of the box and the floor level as shown on the **Fig. 1**) feeding the cables **(E)** (**Fig. 2**) through a previously opened hole in the box. Observe the direction of the box ensuring the hinge is on the left and take care that the box profile is in line with the finished wall profile;

⚠ In order to prevent water ingress we highly recommend using a silicon sealant between the module support frame **(H) and the back box ON THE LEFT, TOP AND RIGHT SIDES ONLY. DON'T USE SILICON SEALANT ON THE BOTTOM SIDE OF THE MODULE SUPPORT FRAME (Fig.12);**

- Continue from step 4 of surface mounting instructions, but at step 7 hook the hinge locks **(N)** as shown on **Fig. 13**.

⚠ Note: if additional holes are made in the surface box, oxidation problems may appear unless the unprotected metal is coated with a protective paint.

NOTES

- The screwdriver's blade has two sides, one flat and one torx, to select one of them unplug the blade from the screwdriver body and plug it into the required side.
- The example shows the use of only one back box bottom hole for wires, this is done to keep file drawings clear. Naturally the installer can use the left hole or the right or both if required.

HOW TO REMOVE THE CARD NAME HOLDER

- To avoid damage to the module front plate, tape the side that will be in contact with the screwdriver blade;
- Insert the screwdriver (flat side) into the card-holder hole as shown in **Fig. 17**;
- Move the screwdriver to the left as shown in **Fig. 18** to extract the card name holder;
- Edit the card name then replace it inside the holder and refit: insert the holder inside its housing from the left or right side then push the other side until it clips into place.

Art. 6758 7" hands free colour display digital videomonitor

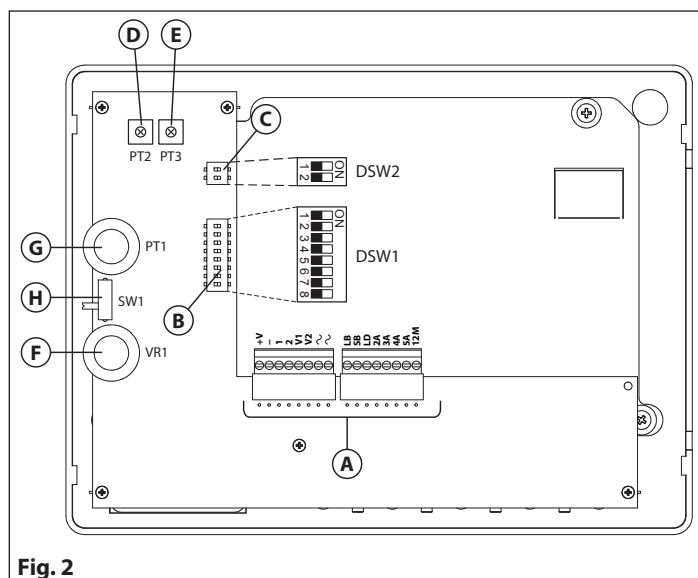
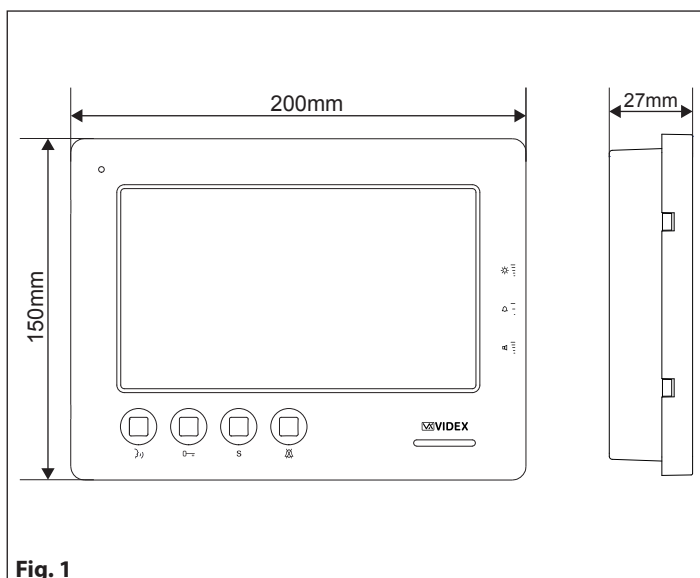

DESCRIPTION

Surface mount hands free videophone incorporating a 7" Hi-Res full colour active matrix LCD monitor specific for "6 wire" videokit (VK4K, VRVK and VK8K range). It includes 4 buttons: "camera recall" "open door" "service" and "privacy".

3 LED's* indicate the privacy activated, open door and activated functions.

Programmable privacy duration, melody type and number of rings. Intercommunicating call and door call.

Adjustments: call tone volume switch (3 levels), picture hue, contrast and brightness.



* The operation of some LED's and the functions described may require additional cabling.

LEGEND

- (A) Connection terminals
- (B) 8 Way dip switch bank to set videophone address
- (C) 2 Way dip switch bank to set video mode
- (D) Hue adjustment trimmer
- (E) Contrast adjustment trimmer*
- (F) Speech volume control
- (G) Brightness control
- (H) Call tone volume switch







* Not available in some LCD versions.

PUSH BUTTONS

S	<p>Service push button. Shorts the SB terminal to GROUND (open collector 24Vdc 100mA max) while the button remain pressed.</p>
	<p>Privacy ON-OFF button. When the system is in stand-by, the pressing of this button activates (LED switched on) or disables (LED switched off) the "privacy" service. The service is automatically disabled when the programmed privacy time expires. When the service is enabled the videophone does not receive calls.</p>
	<p>Door-open / intercommunicating call button. With speech lines open to the entrance panel, press this button to open the door. If the terminal LD is properly connected the relevant LED remains switched ON until the door is closed. <u>Intercommunication only works when the system is in the stand-by condition.</u> Switch 4 of the SW1 dip-switch selects the type of intercommunication:</p> <p>OFF Intercommunication between two apartments - press the key button to call the videophone(s) in the other apartment. A busy tone will signal that the other videophone is in conversation with the door station and so cannot be called.</p> <p>ON Intercommunication between videophones in the same apartment - press the key button one, two, three or four times to call videophone with extension address 1, 2, 3 or 4 (Set on dip-switches 2&3 of SW1).</p> <p><u>Any intercommunicating conversation is always interrupted by an external call (i.e. External calls take priority).</u></p>
	<p>Intercommunication push button. For an intercommunicating call, press as many times as the extension or address value to call (see SW3 Intercommunication Settings).</p>





PUSH BUTTONS

})	Answer push button. On an incoming call, pressing this button allows the user to answer and converse with the visitor. The relevant LED will illuminate.
	Switch off button. With the system switched on (monitor on), momentary operation of the button will switch the video monitor off. The videomonitor will also automatically switch off after a time delay if the button is not pressed. The relevant LED will switch off.
	Camera recall button. Press the button (Press once for door/gate 1, twice for 2 and so on up to a maximum of 4 entrances): the relevant LED switches ON and the monitor switches on showing the video from the door panel. The speech is also live and the door can be opened by pressing  .
	Simplex button. Pressing and holding the button for more than 3 seconds will switch the videomonitor into SIMPLEX speech mode. Press and hold the button to speak to the caller (}) LED will flash rapidly), release the button to listen (}) LED will flash slowly). If the button is not pressed for 10 seconds the videomonitor will switch off. The videomonitor will revert to duplex speech when another call is made.

LEDS		CONTROLS AND ADJUSTMENTS	
	Privacy on LED It illuminates when the privacy service is enabled.	 PT1	Brightness control (sliding wheel).
	Generic use LED It is controlled from the terminals +DOL and -DOL. Normally used to signal the door status (open or closed).	 SW1	Call tone volume control (3 levels).
	ON LED It illuminates when the videophone is switched ON.	 VR1	Speech volume control (sliding wheel).
		PT2	Colour intensity control trimmer (rotate left to increase or right to decrease).
		PT3	Contrast control trimmer* (rotate left to increase or right to decrease). *Not available in some LCD versions.

SETTINGS (DIP-SWITCH)

The videophone setup is carried out by the 2 dip-switch banks.

 SW1	Switch 1 Apartment Address OFF 1 ON 2
 SW1	Switches 2,3 Extension Address OFF OFF 1 ON OFF 2 OFF ON 3 ON ON 4
 SW1	Switch 4 Intercommunication OFF Between videophones in another apartment ON Between videophones in the same apartment
 SW1	Switches 5,6 Number of rings OFF OFF 2 ON OFF 4 OFF ON 6 ON ON 8
 SW1	Switches 7,8 Privacy duration time OFF OFF 15 minutes ON OFF 1 hours OFF ON 4 hours ON ON 8 hours

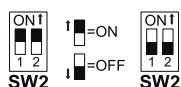

2 WAY DIP-SWITCH (SW2)

The two way dip-switch adjusts the impedance of the video signal. The default setting is "ON" for both switches (75 Ohm): when there are more videophones in parallel connection (without video distributor) both switches must be "ON" only on the last videophone (looking at the connection order) while for all other videophones both switches must be set to "OFF".

MELODY TYPE SETTING

1. Press and keep pressed **0** button for 10 seconds to enter melody type programming mode: the unit plays the current melody and then a "beep";
2. After the "beep" press **0** buttons to select the next melody: a new melody will play for some seconds then the unit emits a "beep". There are 9 melodies available. **Note:** press **0** buttons only after the melody is over and the unit emits the "beep";
3. When desired melody is playing, wait for some seconds: the unit completes the melody and emits a "beep", then the unit emits a double "beep" that confirms the new setting is properly stored;
4. The unit returns to stand-by mode.

CONNECTION TERMINALS SIGNALS

+V	20Vdc Input/Output (As input 16÷20Vdc 0,5A – as output 20Vdc 0,5A max)
-	Ground reference for +V terminal.
1	Speech line output from microphone and data signal (Approx. 12V in stand-by, 5V during a conversation)
2	Speech line input toward the loudspeaker (Approx. 12V in stand-by, approx. 3V during a conversation)
V1	Balanced video signal 1 sync.-
V2	Balanced video signal 2 sync.+
	24Vac 1A max power input
	
LB	Local call input (5V in standby, 0V to trigger)
SB	Service button (open collector) active low output. The button goes active when the button is pressed (Open Collector 24Vdc 100mA max)
LD	12Vdc input for door-open LED
2A	Speech line input toward the loudspeaker of the parallel telephone (Approx. 12V in stand-by, 3V during a conversation)
3A	Output switched ground for parallel telephone
4A	Output call tone for parallel telephone
5A	Input for door-open command from parallel telephone
12M	12Vdc power supply for Memory Board version (optional)

MEMORY BOARD

This device is also available in the version with memory board (Art. 6758/VM).

If you have that version, please refer to the "**6200, 6300, 6400 and 6700 Series Memory Board**" user manual (in English and Italian) for installation and use.

The manual is available for download: click/tap or scan the QR code.

**TECHNICAL SPECIFICATION**

Power Supply:	24Vac in or 20Vdc in
Power consumption:	Stand-by: 50mA Max Operating: 400mA Max
Working Temperature:	-10 +50 °C

6700 Series Wall mounting instructions

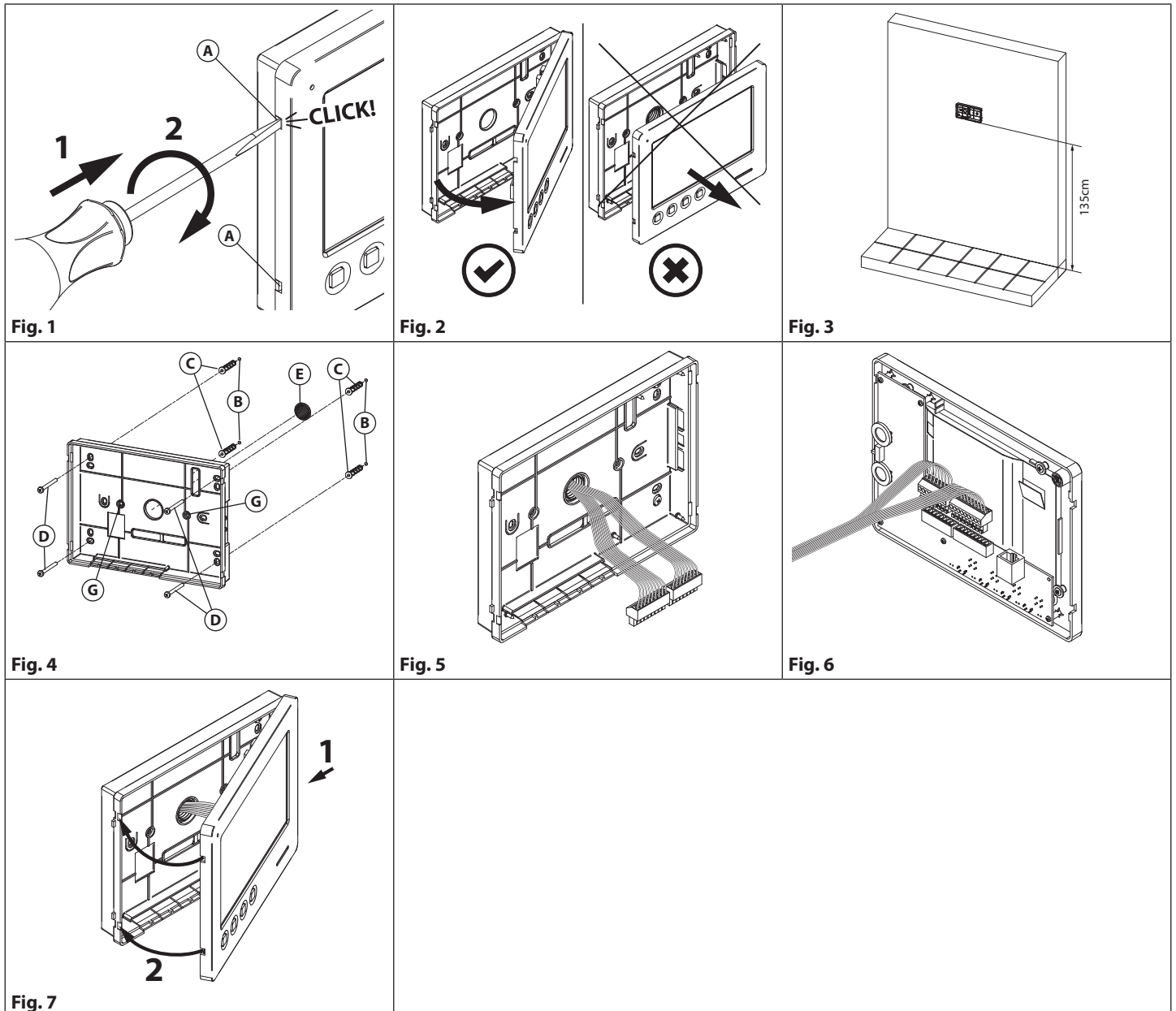

- In order to install the videophone, it is necessary to remove the cover, which contains all the electronics, from the base: insert a 5.5mm flat screw driver into the clip (A) then rotate clockwise until you listen a "CLICK!". Repeat the same operation with the other clip as shown in Fig. 1.
- Pull outwards the left part of the cover as shown in Fig. 2. **Don't pull the cover straight.**
- Put the base of the unit on the wall at approx 135cm from the finished floor (Fig. 3) to match the points for the fixing holes (B) (Fig. 4) remembering that the wires (E) (Fig. 4) must be fed through the large hole (F) (Fig. 4). If you use the flush mounting box 503, embed it into the wall vertically at approx. 140cm from the finished floor and the base.
- Following Fig. 4, make the holes (B), insert the wall plugs (C) and fix the base with the screws (D) feeding the wires (E) through the hole (F). If you have used the box 503, fix the base to the wall through the holes (G) using the screws (D).
- As shown in Fig. 5, connect the wires to the removable terminals following the provided installation diagram. Connect the terminal blocks to the electronics contained in the cover as shown in Fig. 6. Test system before closing.
Contrast and hue trimmers can be adjusted only if the videophone is open. To activate the display and see changes use the "Camera Recall" function by pressing  button.
Note: while testing the system, it is advisable to hold the cover with your hand.
- Once testing is complete and all the necessary adjustments are made, close the unit as shown in Fig. 7: first hook in the right part and then the left part until you hear a "CLICK!".

Art. 316 - Art. 316N

4 Way video distributor for system with balanced video signal

DESCRIPTION

ART. 316

4 Way video distributor for systems with balanced video signal. In white plastic ABS box 11x70x30mm surface mount.

ART. 316N

As Art. 316 but small form factor without terminals to connect "+" (plus) and "-" (minus) from videophones (is required an external connection of these terminals). It is housed in a 50X60X20 mm plastic box which is for surface mounting.

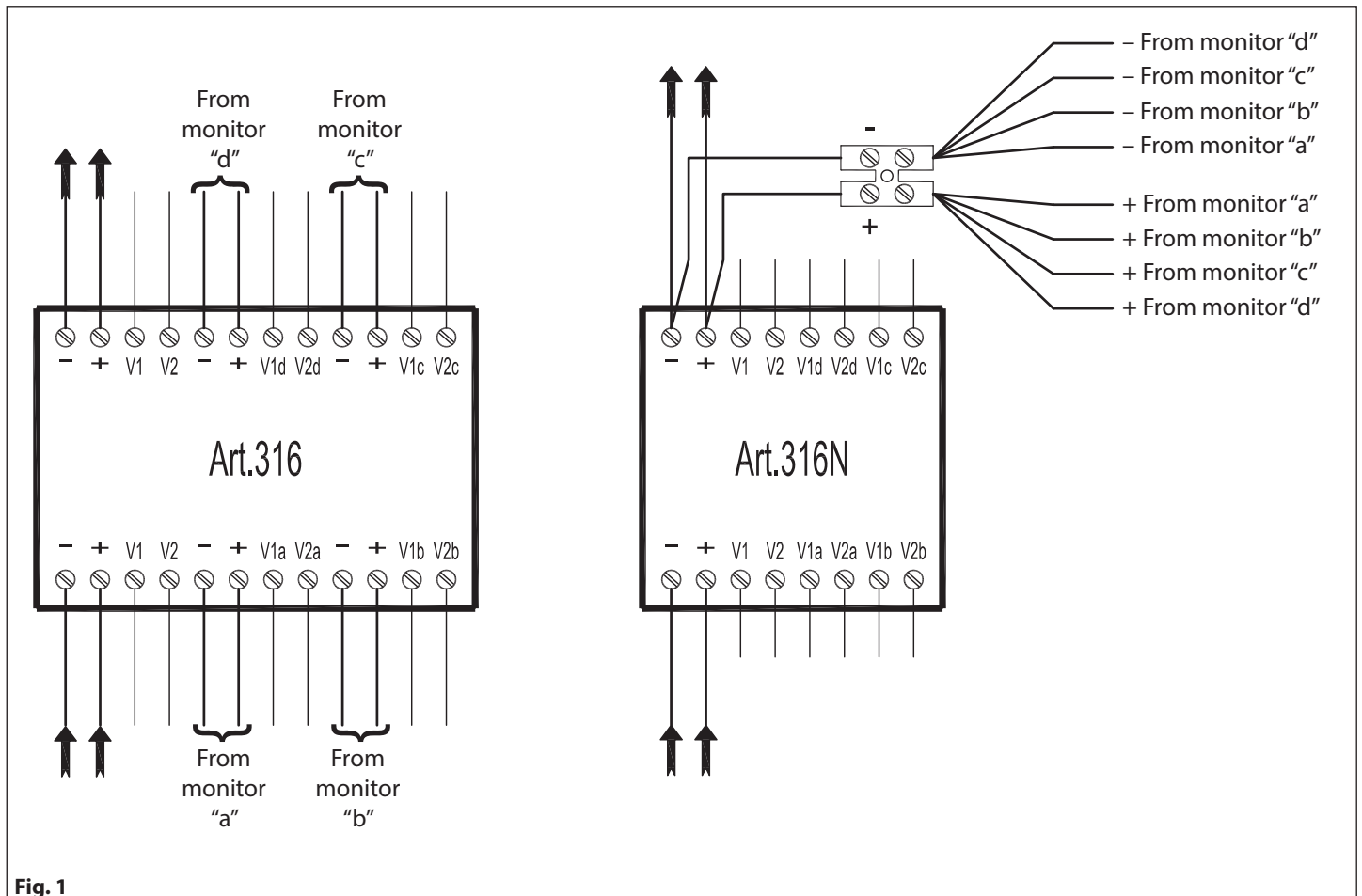
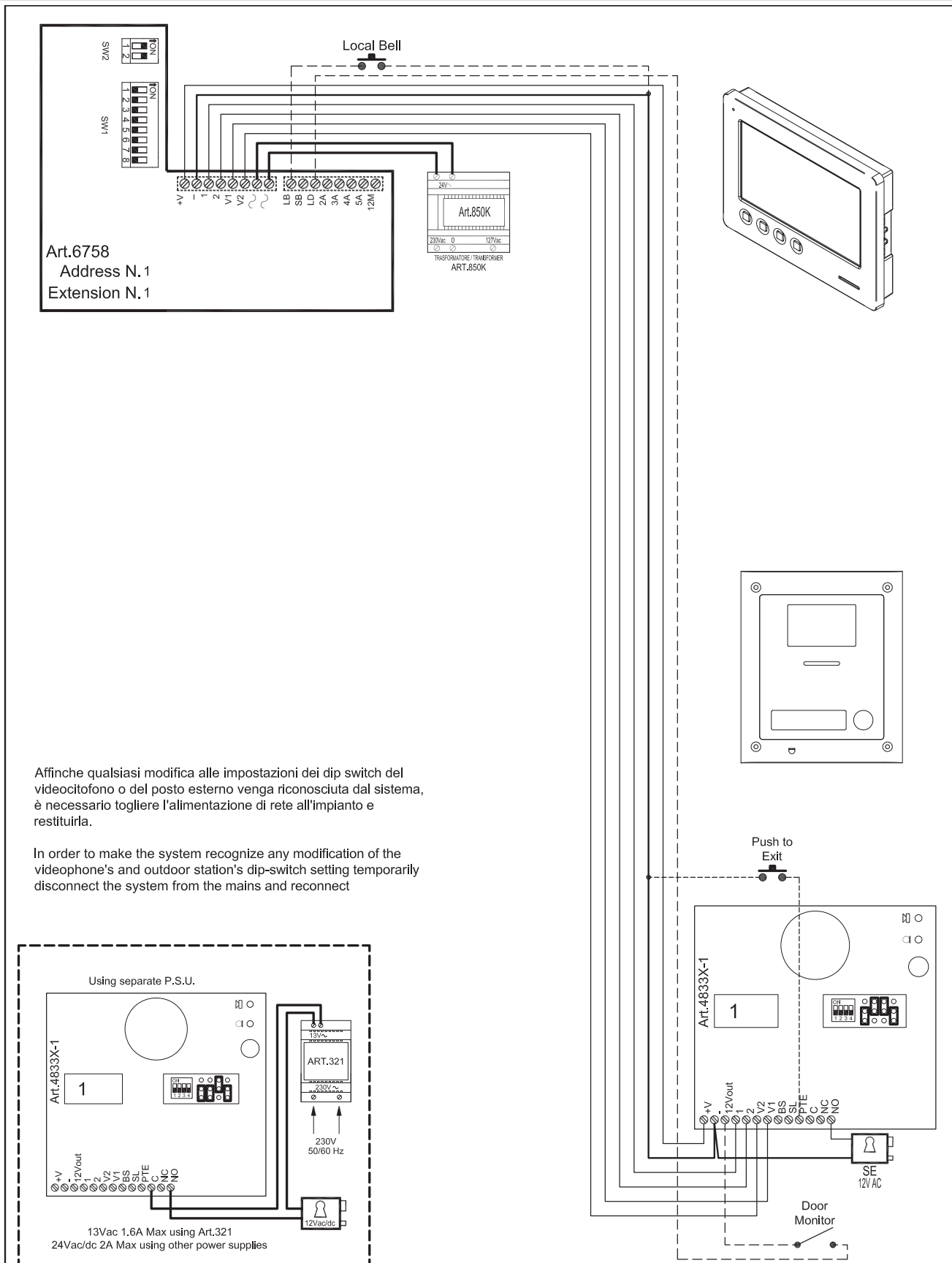



Fig. 1

VIDEOKIT VK4K-1/6758, VK4K-1S/6758



Affinche qualsiasi modifica alle impostazioni dei dip switch del videocitofono o del posto esterno venga riconosciuta dal sistema, è necessario togliere l'alimentazione di rete all'impianto e restituirla.

In order to make the system recognize any modification of the videophone's and outdoor station's dip-switch setting temporarily disconnect the system from the mains and reconnect

Title: VK4K-1/6758, VK4K-1S/6758		Data creazione: 05/09/2017	Foglio 1 / 1
Thols: VK4K-1/6758, VK4K-1S/6758		Data modifica: 05/09/2017	
 Videx Electronics S.p.A. Via del Lavoro 1, 63020 Monte Giberto (AP) Phone: +39 0734 631869 - Fax: +39 0734 631869 www.videx.it - info@videx.it		Autore: Marco Rongoni	Code File: vk4kx67h-002.dwg
Notes: -- Notes: --			

VIDEOKIT VK4K-2/6758, VK4K-2S/6758

Affinche qualsiasi modifica alle impostazioni dei dip switch del videocitofono o del posto esterno venga riconosciuta dal sistema, è necessario togliere l'alimentazione di rete all'impianto e restituirla.

In order to make the system recognize any modification of the videophone's and outdoor station's dip-switch setting temporarily disconnect the system from the mains and reconnect

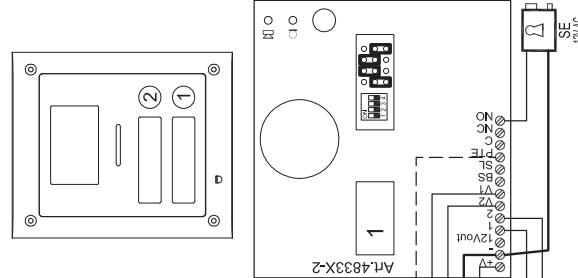
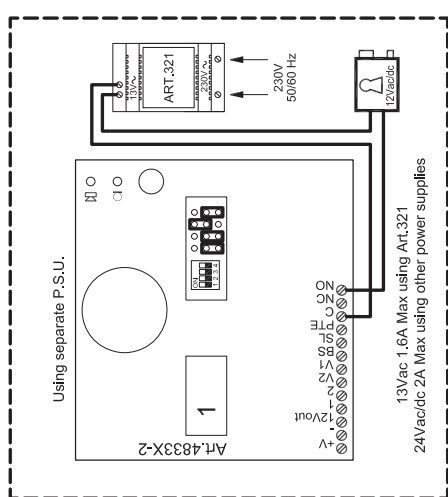
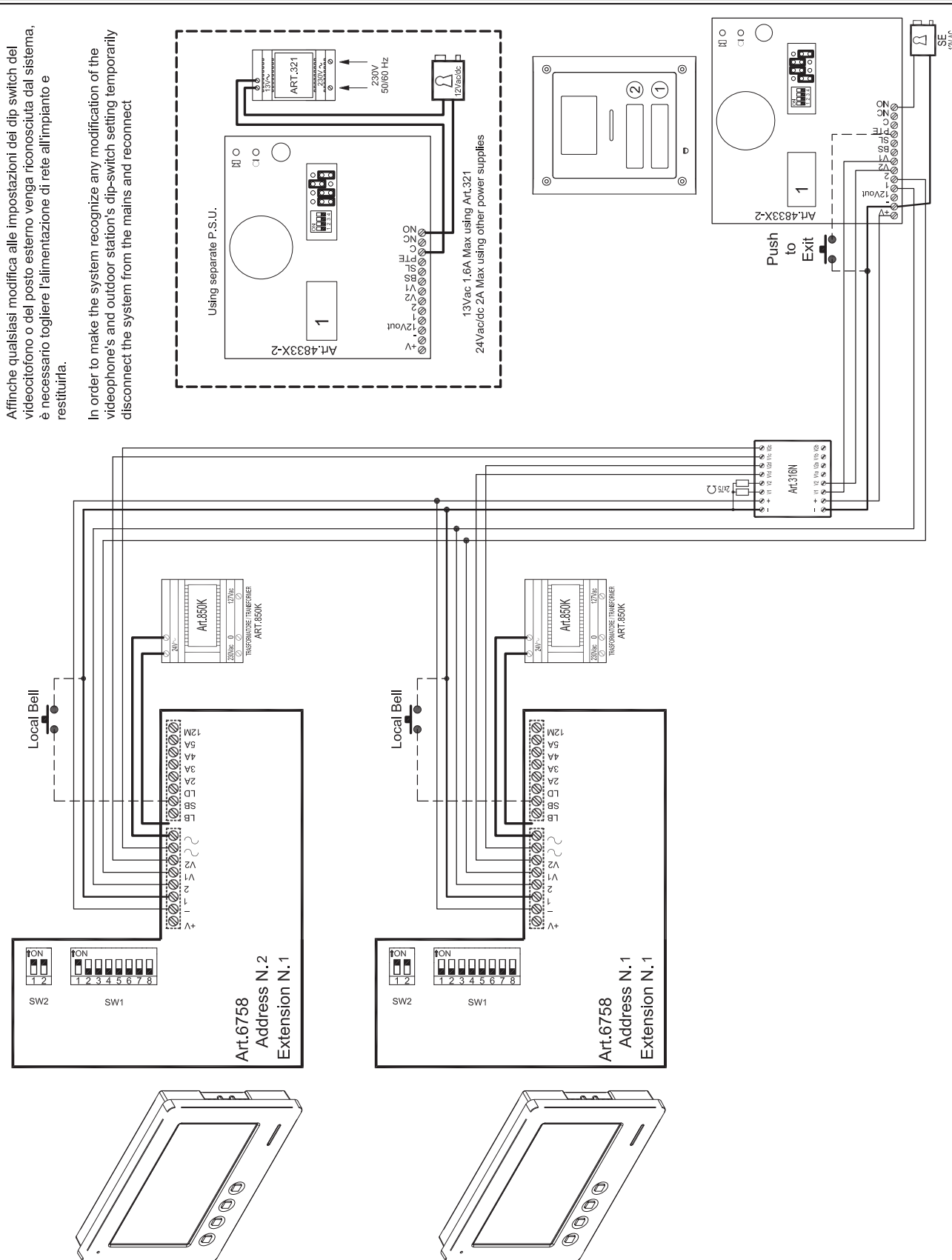

Titolo: VK4K-2/6758, VK4K-2S/6758		Data creazione: 05/09/2017	Foglio 1 / 1
Titolo: VK4K-2/6758, VK4K-2S/6758		Data modifica: 06/09/2017	
 Videx Electronics S.p.A. Via del Lavoro 1, 63846 Monte Giberto (FM) Phone: +39 0734 631669 - Fax +39 0734 631669 www.videx.it - info@videx.it		Note: --- Note: ---	
		Autore: Roberto Gambinii Cod File: vk4kx67h-003.dwg	

VIDEOKIT VK4KC-1/6758, VK4KC-1S/6758

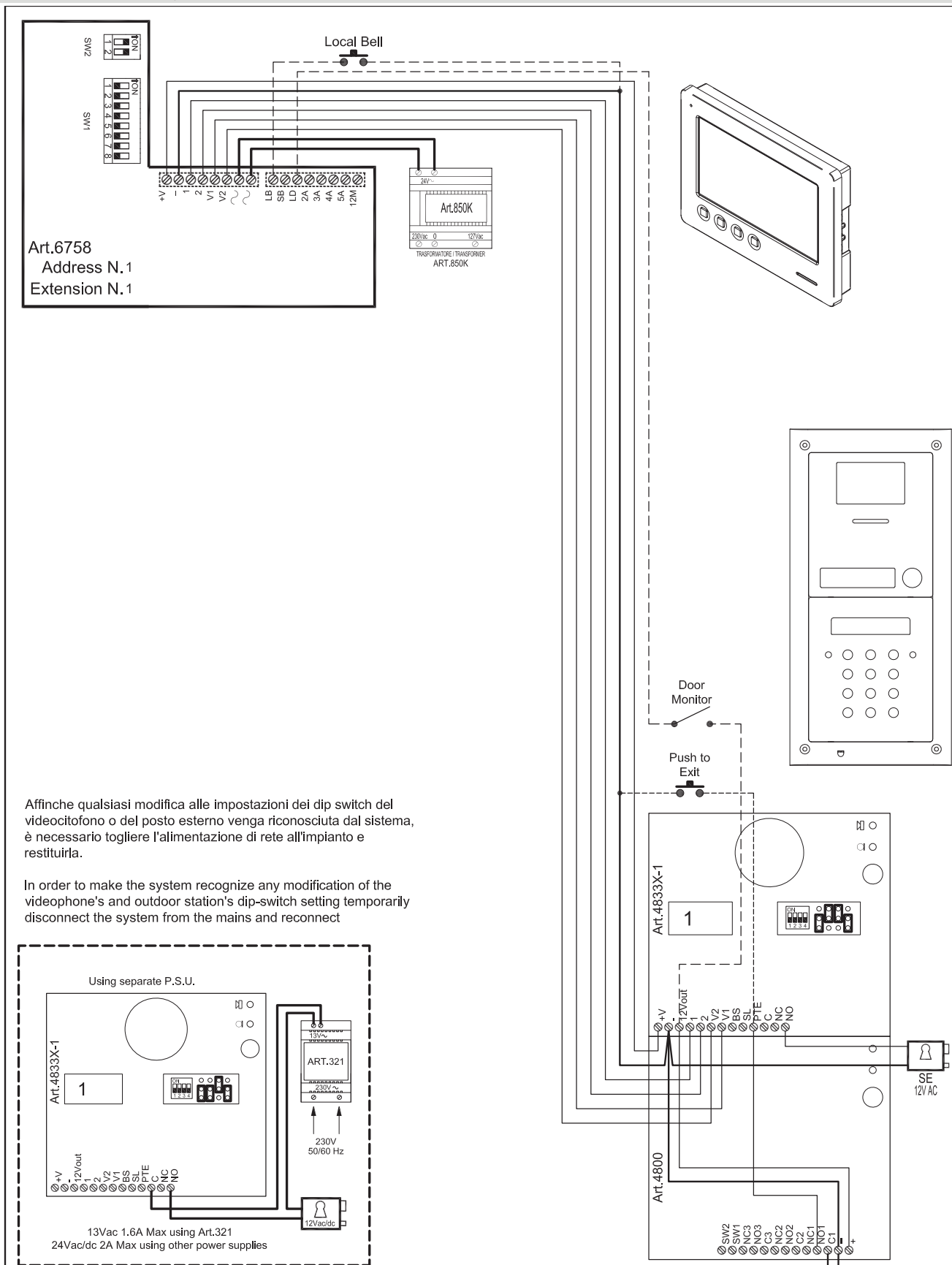

Art.6758
Address N.1
Extension N.1

Affinche qualsiasi modifica alle impostazioni dei dip switch del videocitofono o del posto esterno venga riconosciuta dal sistema, è necessario togliere l'alimentazione di rete all'impianto e restituirla.

In order to make the system recognize any modification of the videophone's and outdoor station's dip-switch setting temporarily disconnect the system from the mains and reconnect

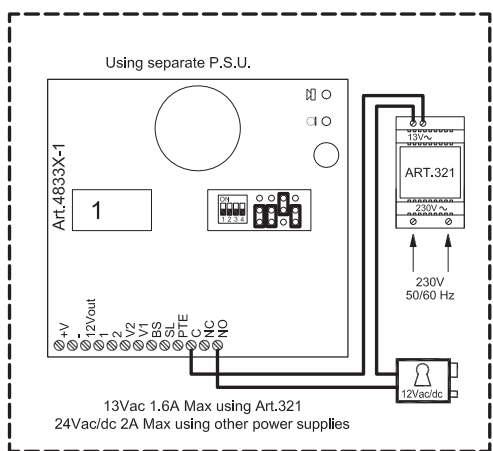

Titolo: VK4KC-1/6758, VK4KC-1S/6758		Data creazione: 05/09/2017	Foglio 1 / 1
Titolo: VK4KC-1/6758, VK4KC-1S/6758		Data modifica: 06/09/2017	
Videx Electronics S.p.A. Via del Lavoro 1, 63846 Monte Giberto (FM) Phone: +39 0734 631669 - Fax: +39 0734 631669 www.videx.it - info@videx.it		Autore: Roberto Gambini Cod File: vk4kx67h-004.dwg	

VIDEOKIT VK4KC-2/6758, VK4KC-2S/6758

Affinche qualsiasi modifica alle impostazioni dei dip switch del videocitofono o del posto esterno venga riconosciuta dal sistema, è necessario togliere l'alimentazione di rete all'impianto e restituirla.

In order to make the system recognize any modification of the videophone's and outdoor station's dip-switch setting temporarily disconnect the system from the mains and reconnect

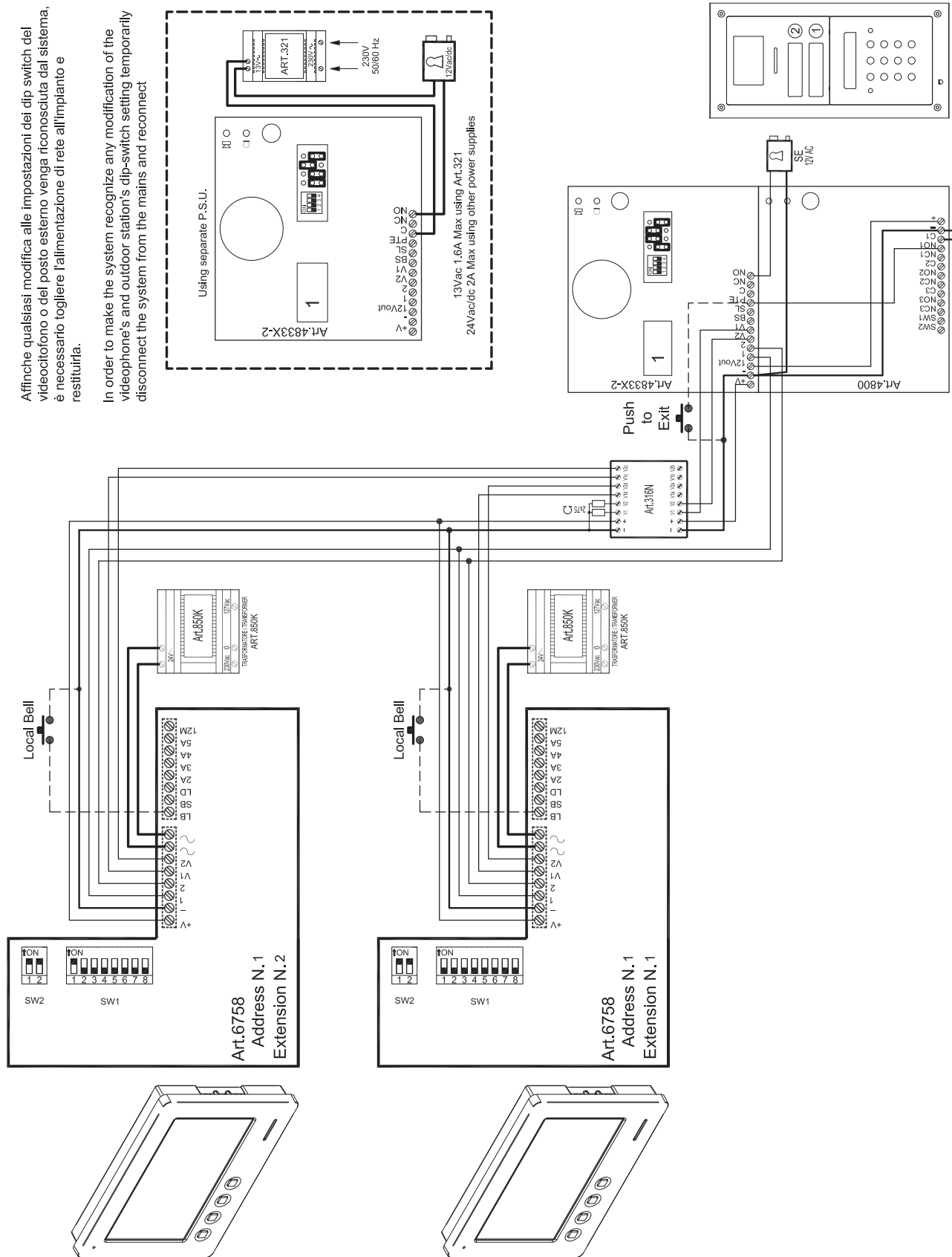

Titolo:
VK4KC-2/6758, VK4KC-2S/6758

Titolo:
VK4KC-2/6758, VK4KC-2S/6758

Videx Electronics S.p.A.
Via del Lavoro 1, 63846 Monte Giberto (FM)
Phone: +39 0734 631669 - Fax: +39 0734 631669
www.videx.it - info@videx.it

Notes:
- -
Note:
- -

Data creazione:
05/09/2017

Data modifica:
06/09/2017

Autore:
Roberto Gambini

Cod. File:
vk4kx67h-005.dwg

Foglio
1 / 1

VIDEOKIT VK4K-1/6758, VK4K-1S/6758 WITH ADDITIONAL INTERCOM AND EXTENSION SOUNDER

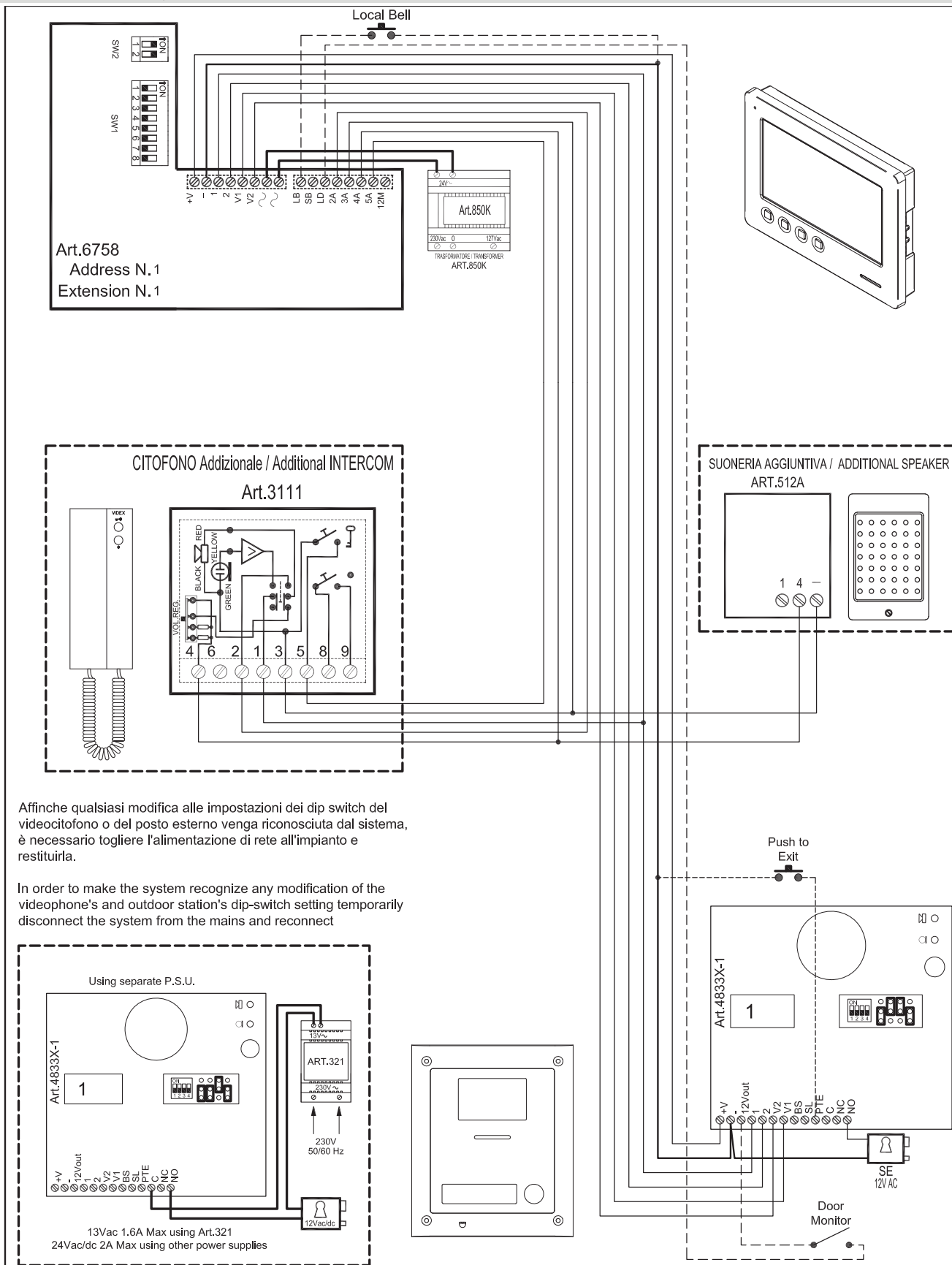

Affinche qualsiasi modifica alle impostazioni dei dip switch del videocitofono o del posto esterno venga riconosciuta dal sistema, è necessario togliere l'alimentazione di rete all'impianto e restituirla.

In order to make the system recognize any modification of the videophone's and outdoor station's dip-switch setting temporarily disconnect the system from the mains and reconnect

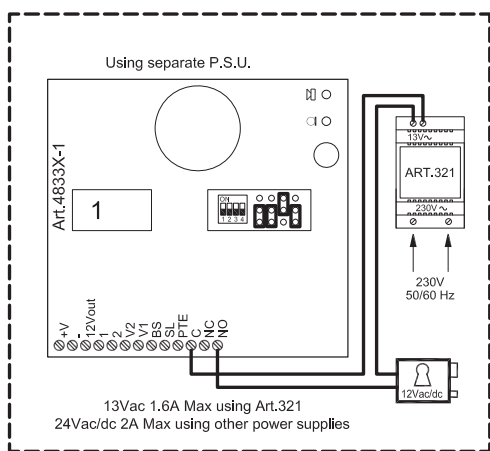

Titolo: VK4K-1/6758, VK4K-1S/6758 plus Additional handset and additional speaker.

Titolo: VK4K-1/6758, VK4K-1S/6758 plus Additional handset and additional speaker.

Videx Electronics S.p.A.
Via del Lavoro 1, 63020 Monte Giberto (AP)
Phone: +39 0734 631669 - Fax: +39 0734 631669
www.videx.it - info@videx.it

Notes:

Note:

Data creazione: 05/09/2017

Data modifica: 05/09/2017

Autore: Marco Rongoni

Cod. File: vk4kx67h-008.dwg

Foglio 1 / 1

VIDEOKIT VK4K-1/6758, VK4K-1S/6758 WITH ADDITIONAL DOOR PANEL FOR 2 ENTRANCES SYSTEM

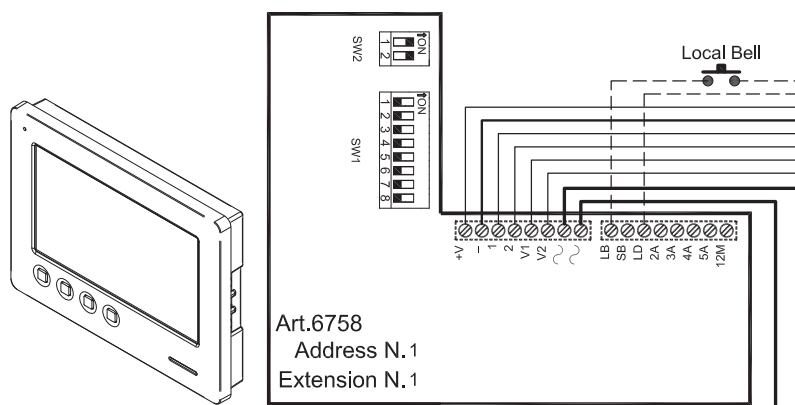

Affinche qualsiasi modifica alle impostazioni dei dip switch del videocitofono o del posto esterno venga riconosciuta dal sistema, è necessario togliere l'alimentazione di rete all'impianto e restituirla.

In order to make the system recognize any modification of the videophone's and outdoor station's dip-switch setting temporarily disconnect the system from the mains and reconnect

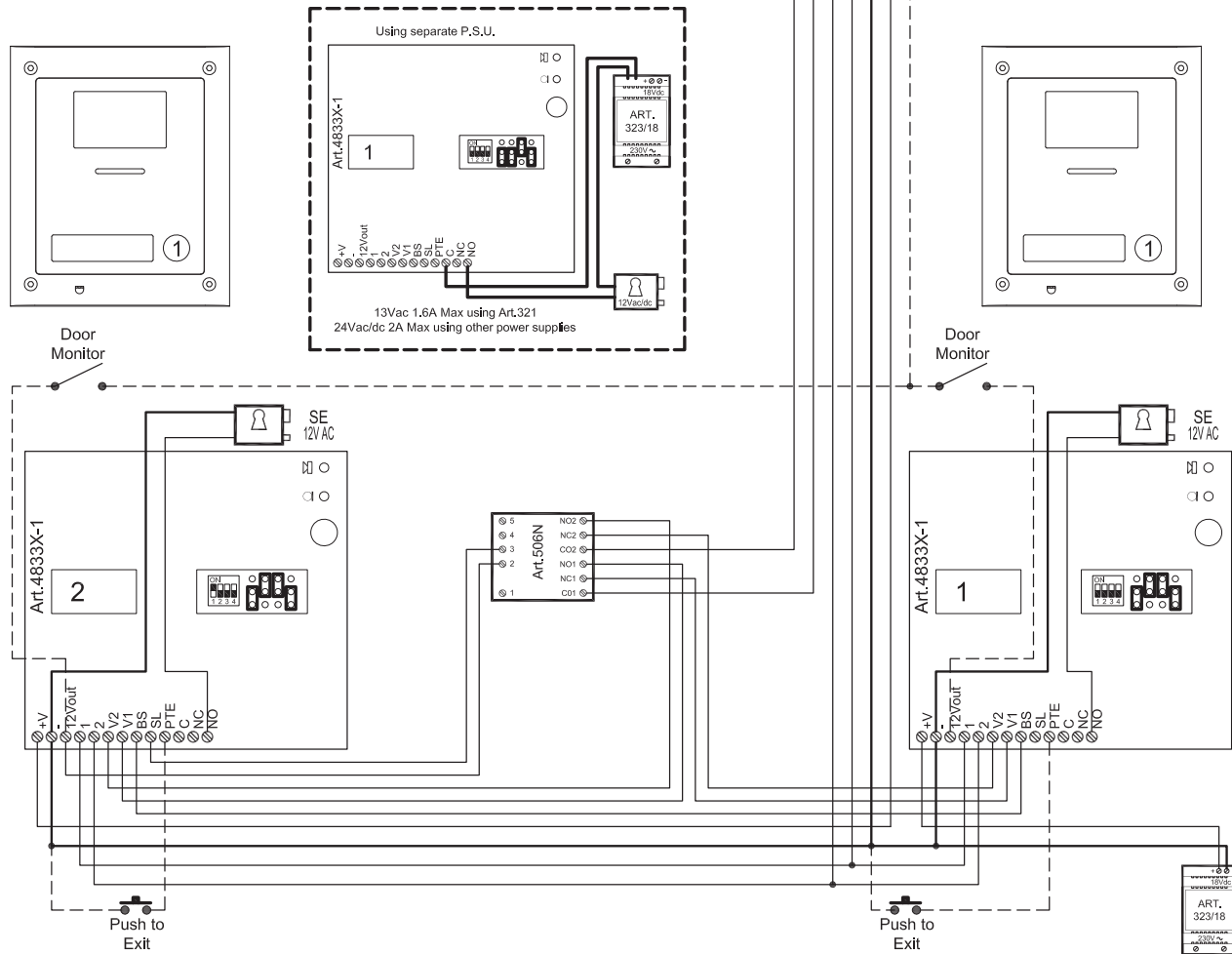
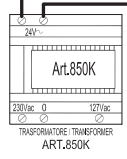

Title: VK4K-1/6758, VK4K-1S/6758 with second door panel for two entrances system		Data creazione: 06/09/2017	Foglio 1 / 1
Titolo: VK4K-1/6758, VK4K-1S/6758 con secondo posto esterno per un sistema a due ingressi		Data modifica: 13/09/2017	
Notes: --- Note: ---		Autore: Roberto Gambini Cod File: vk4kx67h-009.dwg	



VIDEOKIT VK4KC-1/4900/6758 - VK4KC-1S/4900/6758 WITH 3 ADDITIONAL VIDEOPHONES

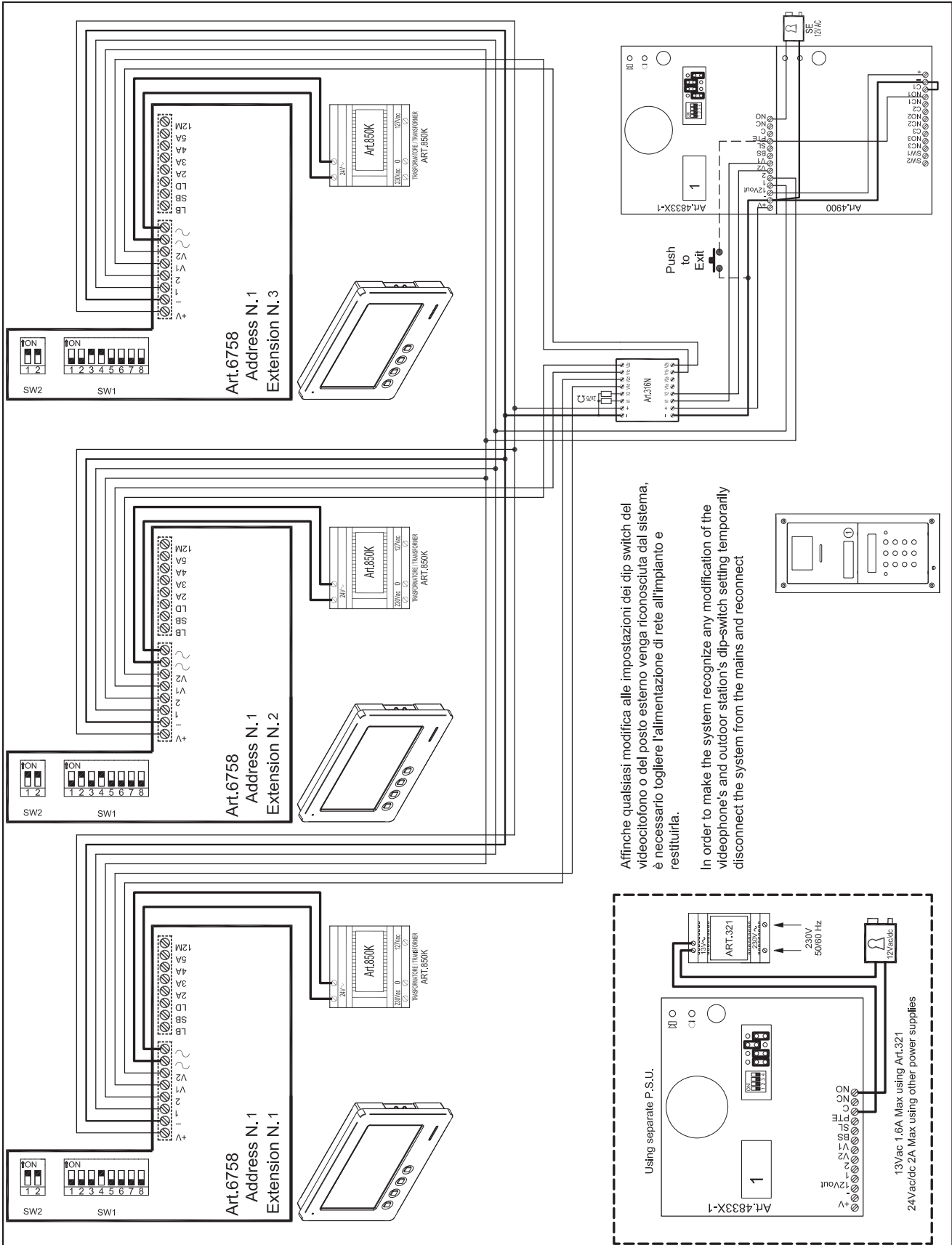

Affinche qualsiasi modifica alle impostazioni dei dip switch del videocitofono o del posto esterno venga riconosciuta dal sistema, è necessario togliere l'alimentazione di rete all'impianto e restituirlo.

In order to make the system recognize any modification of the videophone's and outdoor station's dip-switch setting temporarily disconnect the system from the mains and reconnect

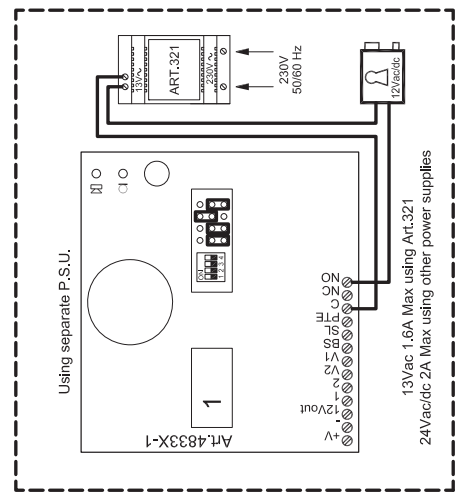

Titolo: VK4KC-1/6758/4900, VK4KC-1S/6758/4900 + 2 additional videophones & Codelock unit Art.4900

Titolo: VK4KC-1/6758/4900, VK4KC-1S/6758/4900 + 2 videocitofoni addizionali & tastiera digitale Art.4900

Videx Electronics S.p.A.
Via del Lavoro 1, 63020 Monte Giberto (AP)
Phone: +39 0734 631669 - Fax: +39 0734 631669
www.videx.it - info@videx.it

Notes:
Flat address of all videophones is the same while videophone address is different for each videophone
Note:
L'indirizzo d'appartamento è lo stesso per tutti i videocitofoni mentre cambia l'indirizzo di interno

Data creazione:	06/09/2017	Foglio	1 / 1
Data modifica:	13/09/2017		
Autore:	Marco Rongoni		
Cod. File:	vk4kx67h-010.dwg		

VIDEOKIT VK4K-1/6758 - VK4K-1S/6758 WITH EXTERNAL CAMERA CONTROLLED BY SERVICE PUSH BUTTON

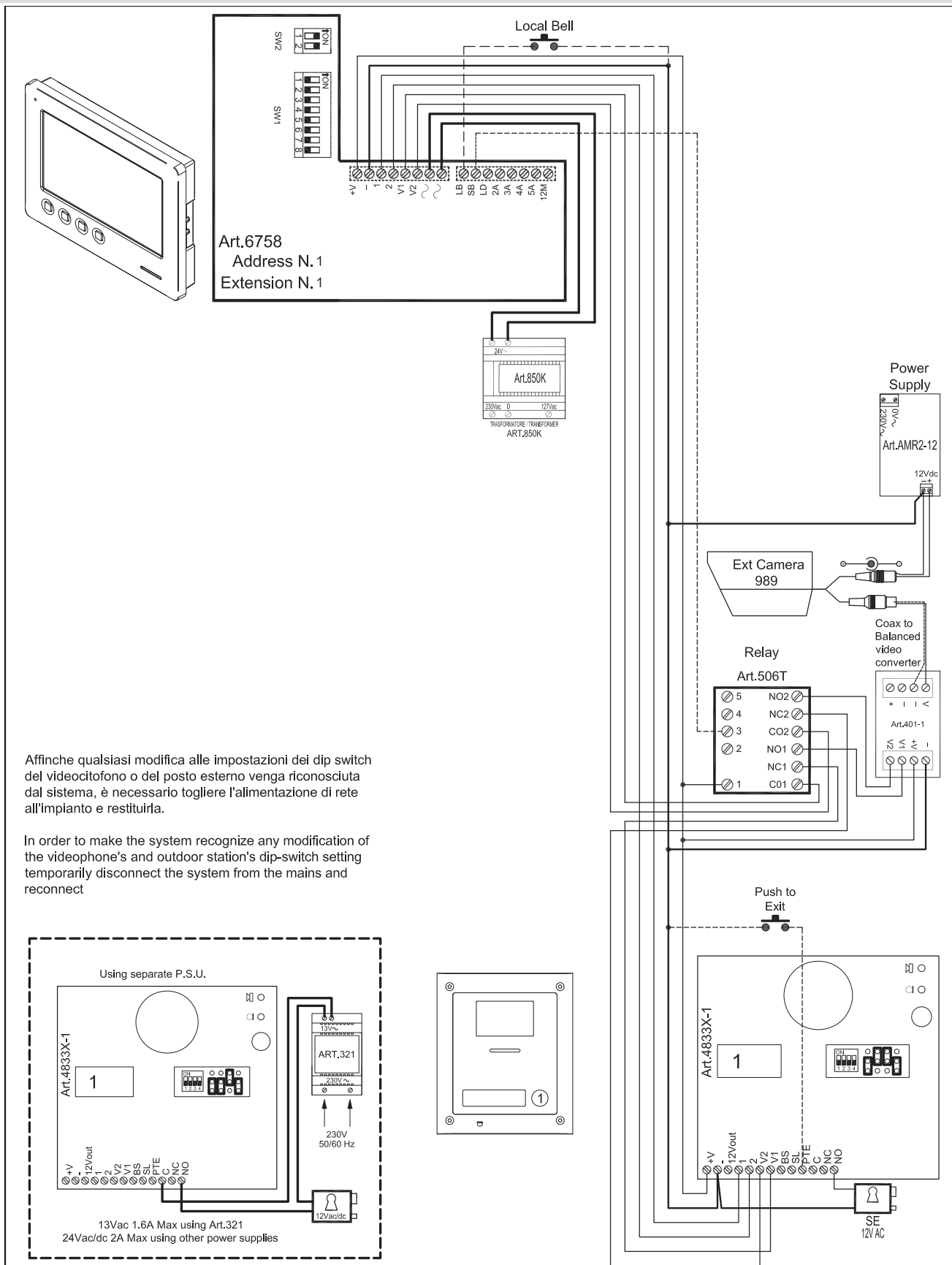

Affinche qualsiasi modifica alle impostazioni dei dip switch del videocitofono o del posto esterno venga riconosciuta dal sistema, è necessario togliere l'alimentazione di rete all'impianto e restituirla.

In order to make the system recognize any modification of the videophone's and outdoor station's dip-switch setting temporarily disconnect the system from the mains and reconnect

Title: VK4K-1/6758, VK4K-1S/6758 with additional external camera		Date creazione: 06/09/2017	Foglio 1 / 1
Titolo: VK4K-1/6758, VK4K-1S/6758 con telecamera esterna aggiuntiva		Data modifica: 13/09/2017	
Videx Electronics S.p.A. Via del Lavoro 1, 63846 Monte Giberto (FM) Phone: +39 0734 631669 - Fax: +39 0734 631669 www.videx.it - info@videx.it		Autore: Roberto Gambini Cod File: vk4kx67h-011.dwg	

VIDEOKIT VK4KC-1/6758 - VK4KC-1S/6758 WITH ADDITIONAL VIDEOPHONE

Affinche qualsiasi modifica alle impostazioni dei dip switch del videocitofono o del posto esterno venga riconosciuta dal sistema, è necessario togliere l'alimentazione di rete all'impianto e restituirla.

In order to make the system recognize any modification of the videophone's and outdoor station's dip-switch setting temporarily disconnect the system from the mains and reconnect

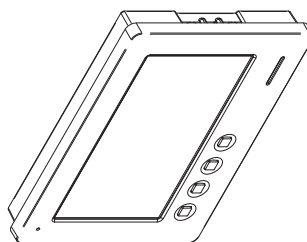
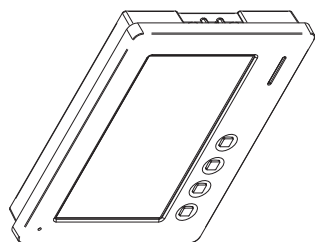
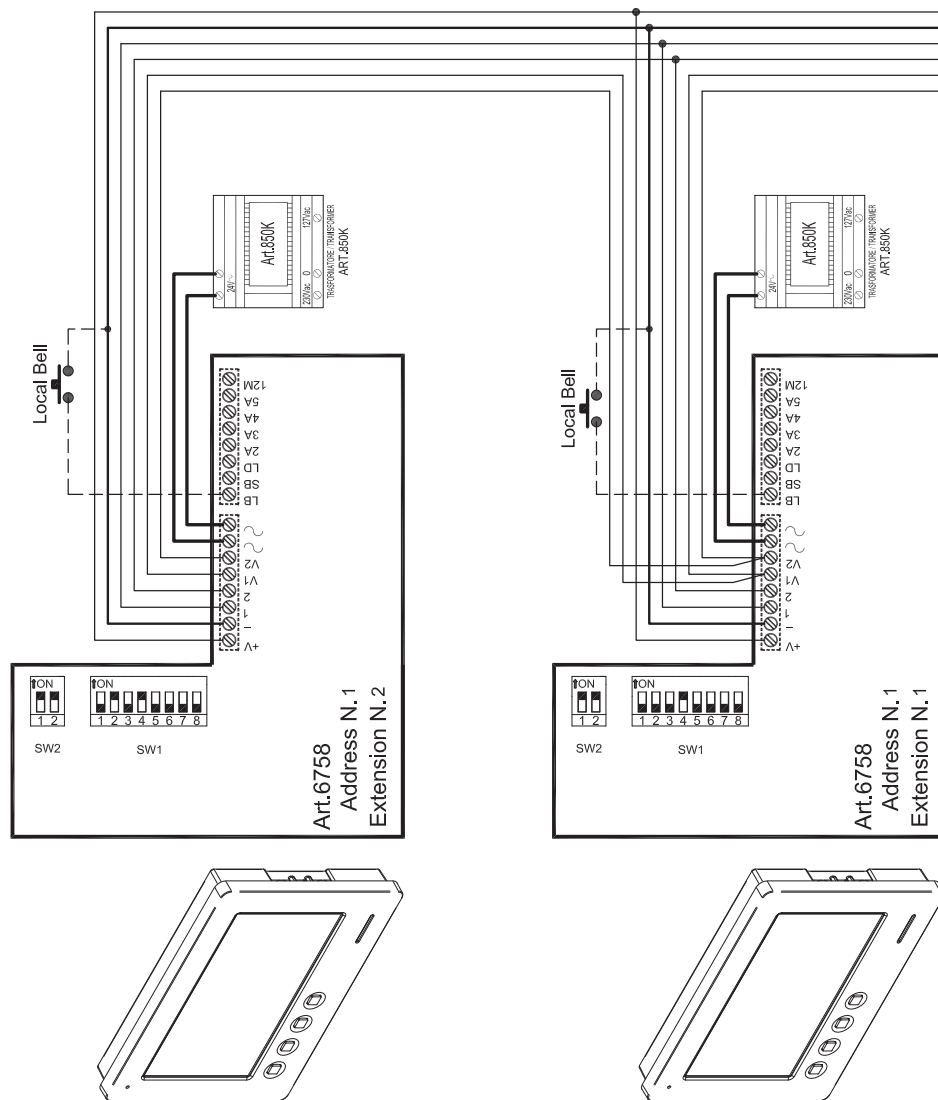
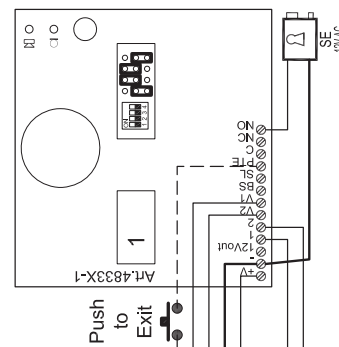
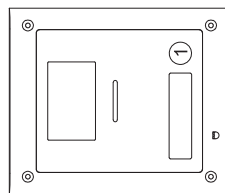
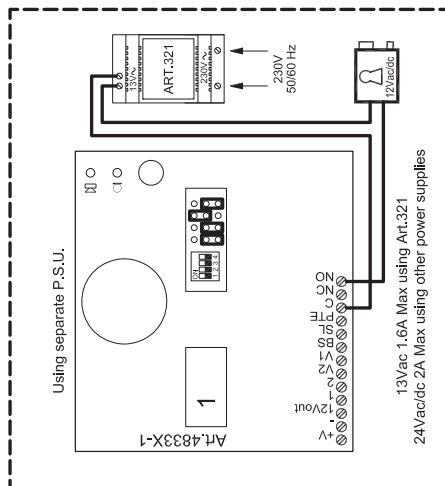

Titolo: VK4K-1/6758, VK4K-1S/6758 with additional videophone without video distributor

Data creazione: 06/09/2017 Foglio 1 / 1

Titolo: VK4K-1/6758, VK4K-1S/6758 con videocitofono addizionale senza distributore video

Data modifica: 06/09/2017

Videx Electronics S.p.A.
Via del Lavoro 1, 63846 Monte Giberto (FM)
Phone: +39 0734 631669 - Fax: +39 0734 631669
www.videx.it - info@videx.it

Notes:
-
-
-

Autore: Roberto Gambini
Cod. File: vk4kx67h-012.dwg

VIDEOKIT VK4K-2/6758 - VK4K-2S/6758 WITH ART. 316

Affinche qualsiasi modifica alle impostazioni dei dip switch del videocitofono o del posto esterno venga riconosciuta dal sistema, è necessario togliere l'alimentazione di rete all'impianto e resettirla.

In order to make the system recognize any modification of the videophone's and outdoor station's dip-switch setting temporarily disconnect the system from the mains and reconnect

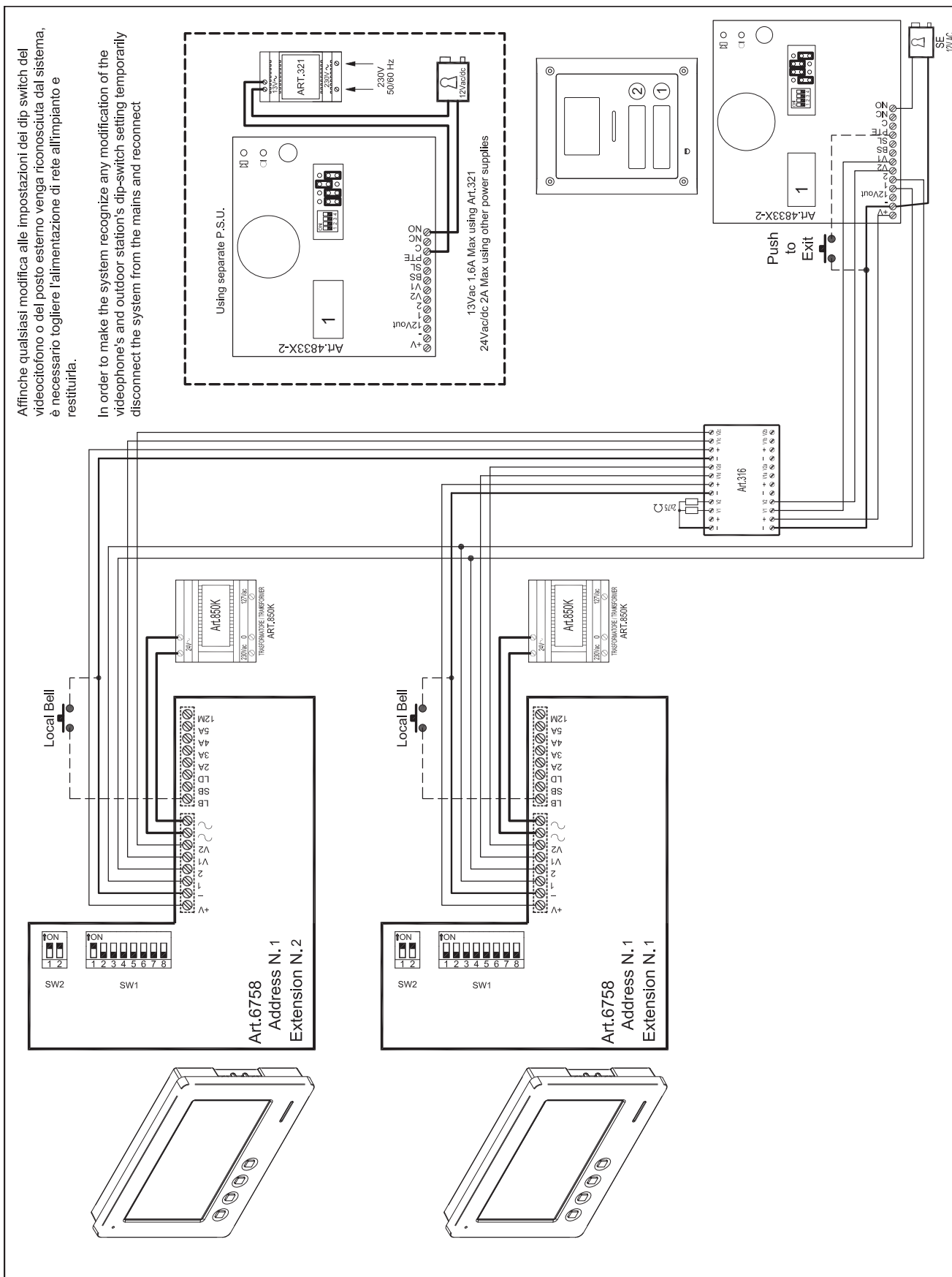

Title: VK4K-2/6758, VK4K-2S/6758		Date creazione: 05/09/2017	Foglio 1 / 1
Titolo: VK4K-2/6758, VK4K-2S/6758		Data modifica: 13/09/2017	
 Videx Electronics S.p.A. Via del Lavoro 1, 63020 Monte Gaudio (AP) Phone: +39 0734 631869 - Fax: +39 0734 631869 www.videx.it - info@videx.it		Notes: --- Note: ---	
		Autore: Marco Rongoni Cod. File: vk4kx67h-001.dwg	

TWO ENTRANCES SYSTEM INSTALLATION

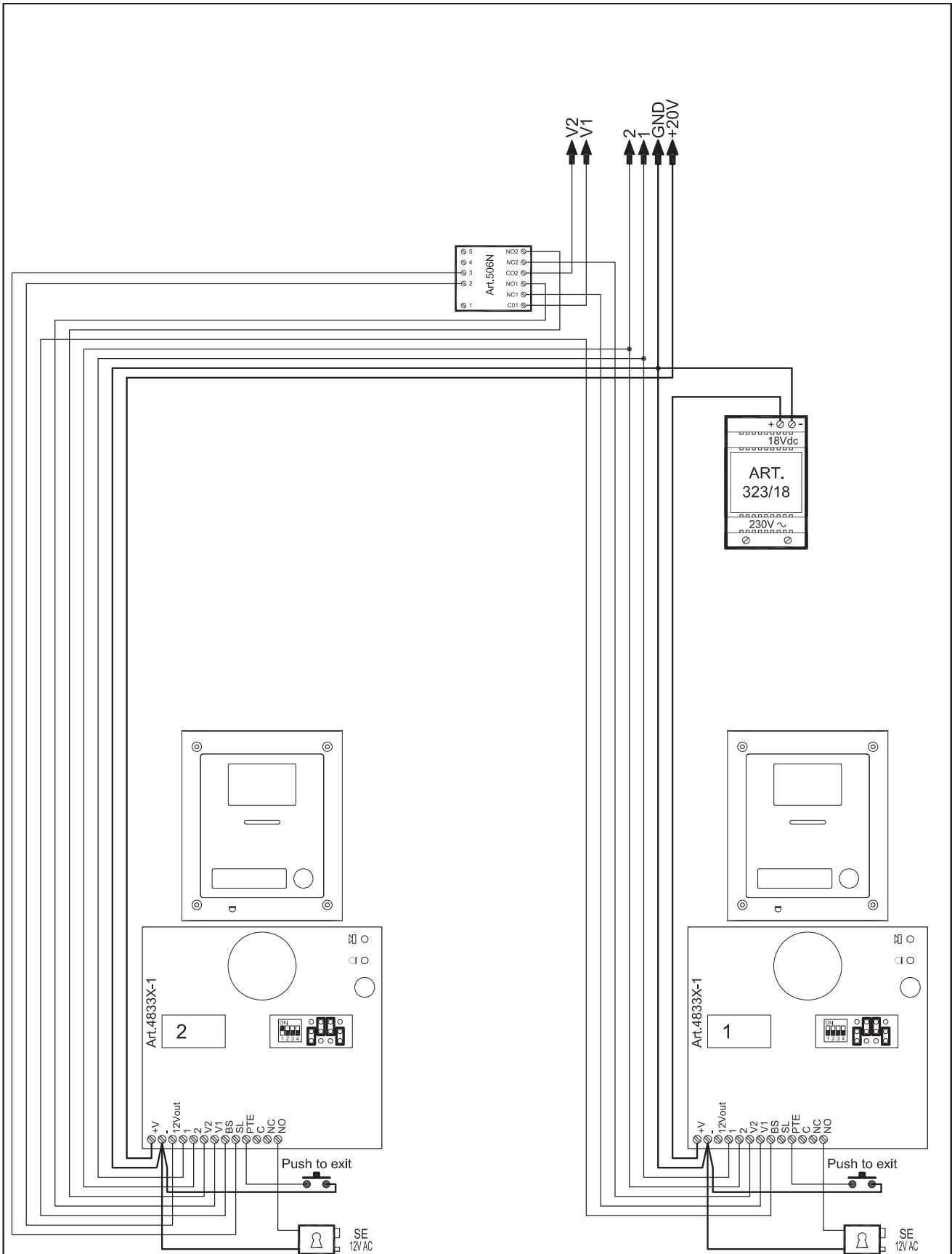

Title: VK4KX-1, VK4KX-1S with second door panel for two entrances system		Data creazione: 26/09/2017	Foglio 1 / 1
Titolo: VK4KX-1, VK4KX-1S con secondo posto esterno per un sistema a due ingressi		Data modifica: 26/09/2017	
Notes: _____ Note: _____		Autore: Marco Rongoni Cod. File: vk4kx-1-001-2e.dwg	



Videx Electronics S.p.A.
 Via del Lavoro 1, 63846 Monte Giberto (FM)
 Phone: +39 0734 631669 - Fax: +39 0734 631669
 www.videx.it - info@videx.it

FOUR ENTRANCES SYSTEM INSTALLATION

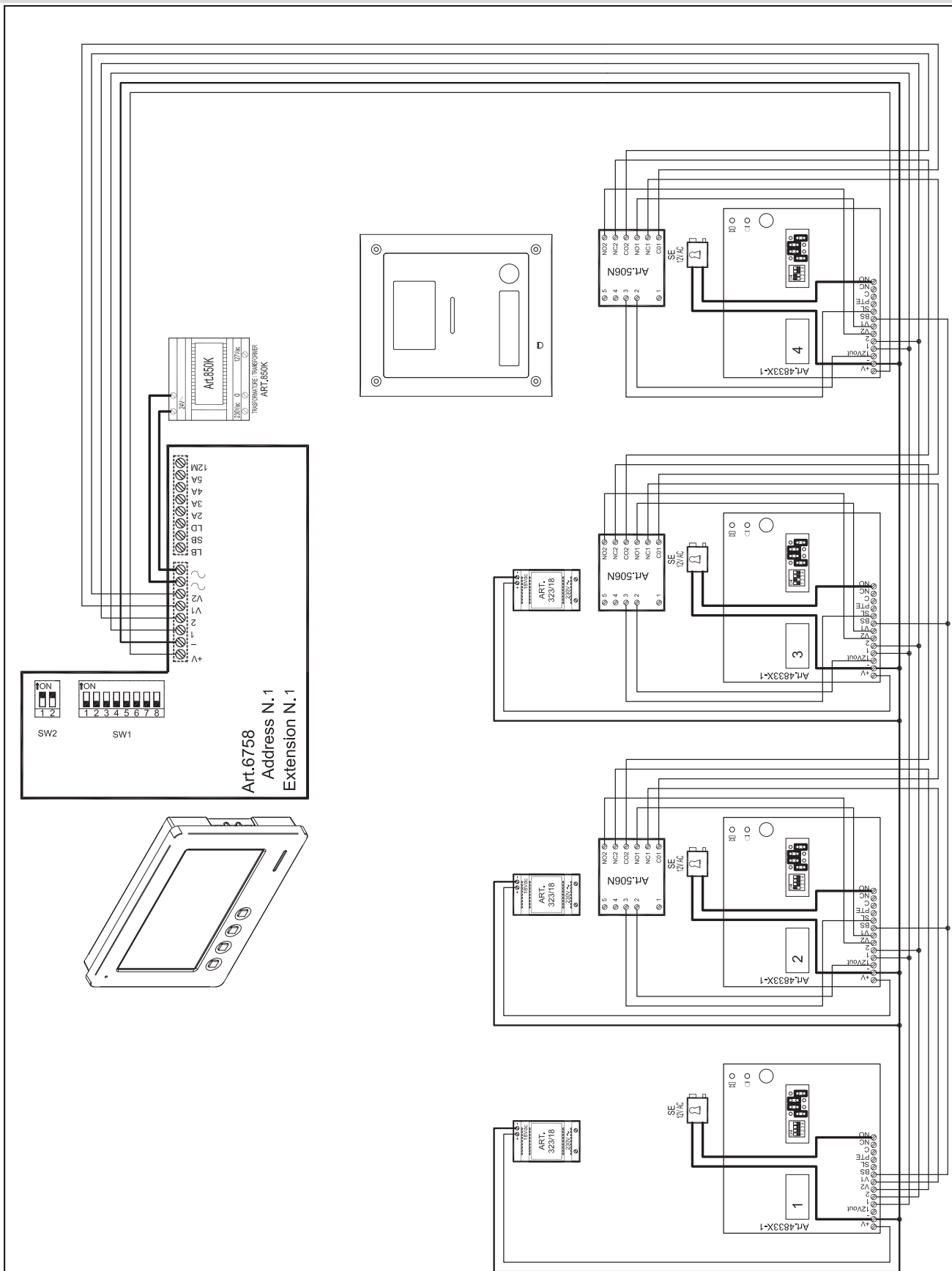

Titolo: VK4K-1/6758, VK4K-1S/6758 with 3 additional door panels for four entrances system

Titolo: VK4K-1/6758, VK4K-1S/6758 con 3 posti esterni addizionali un sistema a 4 ingressi

Videx Electronics S.p.A.
 Via del Lavoro 1, 63020 Monte Giberto (AP)
 Phone: +39 0734 631669 - Fax: +39 0734 631669
 www.videx.it - info@videx.it

Notes:

 Note:

Data creazione: 05/09/2017

Data modifica: 13/09/2017

Autore: Marco Rongoni

Cod. File: vk4kx67h-013.dwg

Foglio 1 / 1

